

tweet®

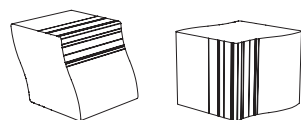

Es forma, textura y color. Un asiento orgánico, compacto y multifuncional. Su movilidad y modulación hacen que su principal calidad sea la de creación de espacios. Sus usos cambian en función de su posición. Invita al juego, al diálogo y a la relajación.

It is form, texture and colour. An organic, compact, multifunctional seat. It literally creates new spaces thanks to its mobility and modular form. Its use can change depending on where it is used. It invites play, dialogue or simply relaxation.



características characteristics



medidas | sizes:
45 x 45 x 57,9 cm

peso | weight:
160 Kg

acabado | finish:
SMOOTH

color | colour:

White, metal, fusion, black, basalt, red, yellow, blue

colocación | fixing:

Base fija. Anclado con tornillos | Fixed base. Anchored with screws

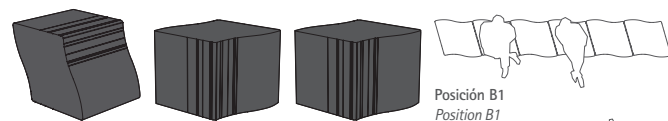

Planta | Plan view

Posición A
Position A

Posición B1
Position B1

Posición B2
Position B2

Posición B1
Position B1

Posición B2
Position B2

45 x 45 x 57,9 cm
Peso | Weight: 160 Kg

58,4 x 45 x 46,7 cm
Peso | Weight: 160 Kg

45 x 45 x 57,9 cm
Peso | Weight: 160 Kg

combinaciones combinations

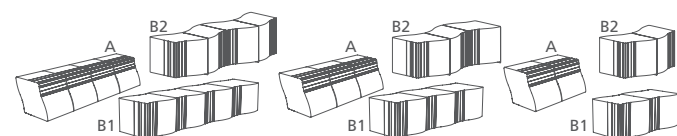

banco de 4 unidades
4 unit bench

banco de 3 unidades
3 unit bench

banco de 2 unidades
2 unit bench

A | 182 x 47 x 57,9 cm
B1 | 200,6 x 47 x 46,7 cm
B2 | 182 x 47 x 57,9 cm

A | 136 x 47 x 57,9 cm
B1 | 153 x 47 x 46,7 cm
B2 | 136 x 47 x 57,9 cm

A | 90 x 45 x 57,9 cm
B1 | 105,8 x 45 x 46,7 cm
B2 | 90 x 45 x 57,9 cm

opciones options

SEPARADORES METÁLICOS DECORATIVE METAL SPACER	•
RUEDAS WHEELS	
LED	
REFLECTANTE REFLECTING	
HIDRO HYDRO	
TAPA TOP	
ARO SUJETA BOLSA TASH BAG FIXING RING	
CENICERO ASHTRAY	
APOYABRAZOS ARMREST	
RESPALDO BACKREST	
MODULABLE MODULABLE	•
WOODY/SYNTREWOOD	

breinco Colors

SMOOTH



white

metal

fusion



black



basalt



red



yellow



blue

geometría geometry

ESCALA 0 CM 25 CM

Posición A | Position A banco de 4 unidades / 4 unit bench

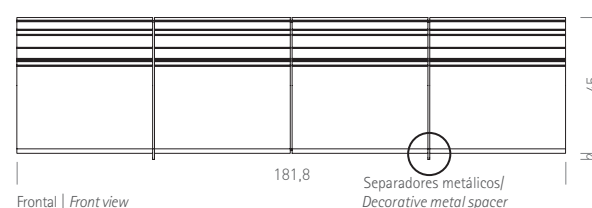

Frontal | Front view

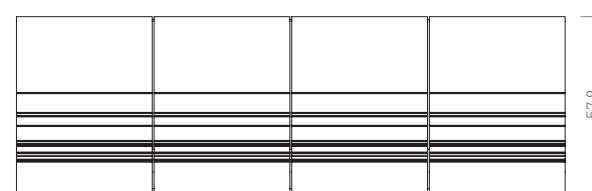

Planta | Plan view

Posición B1 | Position B1 banco de 4 unidades / 4 unit bench

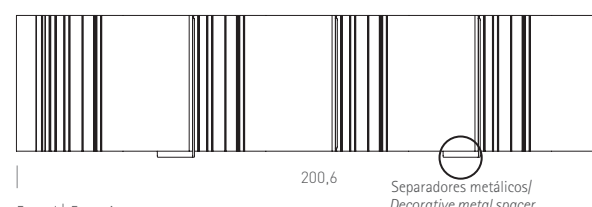

Frontal | Front view

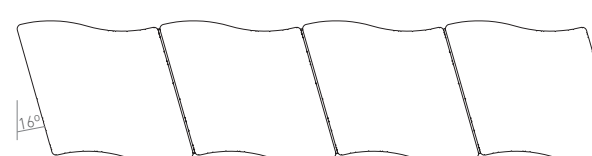

Planta | Plan view

Posición B2 | Position B2 banco de 4 unidades / 4 unit bench

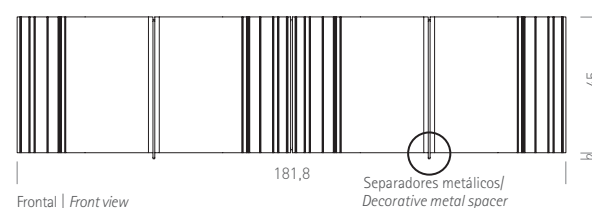

Frontal | Front view

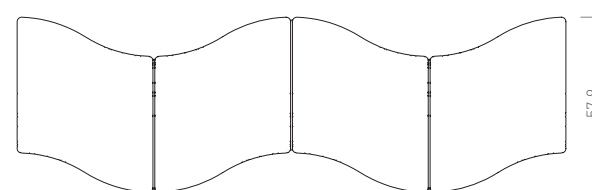

Planta | Plan view

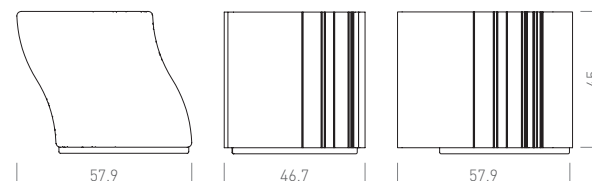

Lateral | Side view
Posición A | Position A

Lateral | Side view
Posición B1 | Position B1

Lateral | Side view
Posición B2 | Position B2

instalación installation

ELEVACIÓN | HOISTING (PIW=212 Kg.)

Posición A | Position A

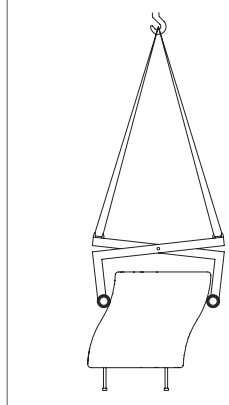

Roscar los tornillos M-12x140.
Taladrar el pavimento (ø30x150)
y llenar con mortero o resina.

Con el elemento se entregan la plantilla y los
pernos de anclaje. Disponibles herramientas
de manipulación.

Tighten the M-12x140 screws. Drill
holes in the paving (ø30x150) and fill
with mortar or resin.

The template and anchoring bolts are supplied
with the element. Tools available for handling.

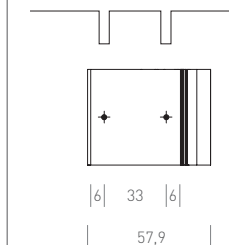

Posición B | Position B

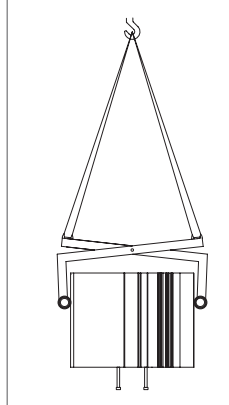

Roscar los tornillos M-12x140.
Taladrar el pavimento (ø30x150)
y llenar con mortero o resina.

Con el elemento se entregan la plantilla y los
pernos de anclaje. Disponibles herramientas
de manipulación.

Tighten the M-12x140 screws. Drill
holes in the paving (ø30x150) and fill
with mortar or resin.

The template and anchoring bolts are supplied
with the element. Tools available for handling.

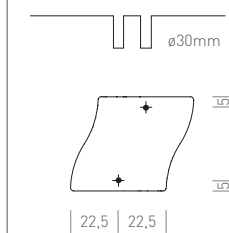

circle puff

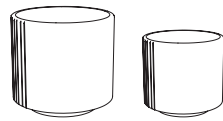

Igual que una piedra para reposar, un hito o término en un cruce, esta pieza es utilizada en las situaciones más ancestrales y es idónea en lugares estratégicos de relación social, de relajación o simplemente para buscar sol y sombra.

In the same way that a resting stone or a milestone at a crossroads has been used for time immemorial at strategic positions for human interaction, this piece can be used to relax or just to find some sun or shade.

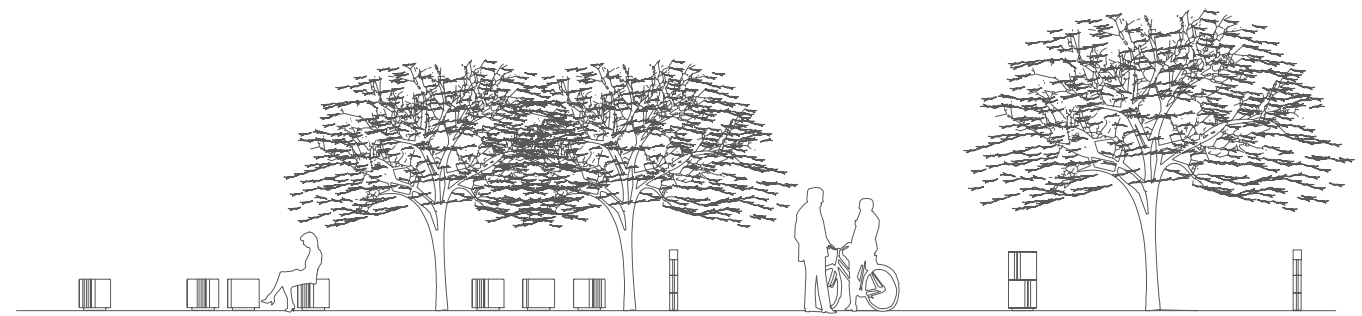

características characteristics



- medidas | sizes:
 Ø45 x 45 cm Ø60 x 50 cm
 peso | weight:
 160 Kg 300 Kg
 acabado | finish:
SMOOTH
 color | colour:
 White, metal, fusion, black, basalt, red, yellow, blue
 colocación | fixing:
 Base fija. Anclado con tornillos | Fixed base. Anchored with screws
 complementos | complements:
 • Iluminación LED | LED lighting
 • Material sostenible woody & syntrewood | Sustainable material woody & syntrewood

combinaciones combinations



material sostenible woody / sustainable material woody

opciones options

SEPARADORES METÁLICOS DECORATIVE METAL SPACER	
RUEDAS WHEELS	
LED	●
REFLECTANTE REFLECTING	
HIDRO HYDRO	
TAPA TOP	
ARO SUJETA BOLSA TASH BAG FIXING RING	
CENICERO ASHTRAY	
APOYABRAZOS ARMREST	
RESPALDO BACKREST	
MODULABLE MODULABLE	
WOODY/SYNTREWOOD	●

breinco Colors

SMOOTH



geometría geometry

ESCALA 0 CM 25 CM

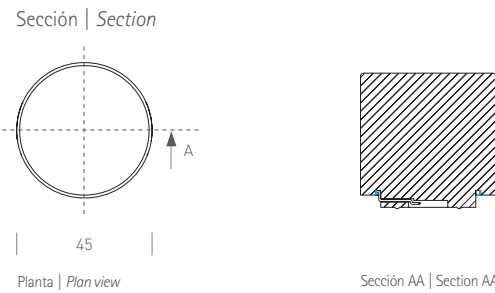
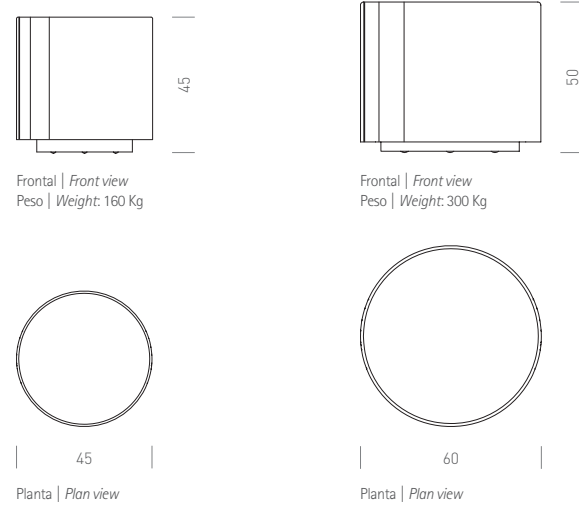

instalación installation

ELEVACIÓN | HOISTING (P)W=160 Kg.)

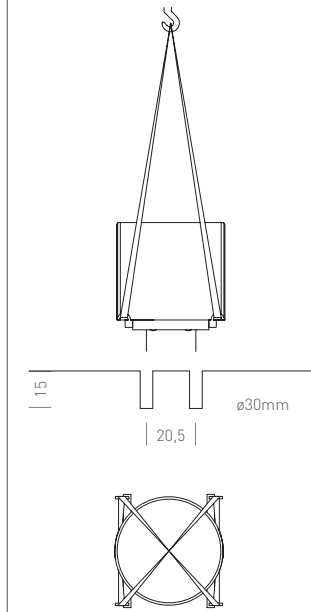

Roscar los tornillos M-12x140. Taladrar el pavimento (ø30x150) y llenar con mortero o resina.

Con el elemento se entregan la plantilla y los pernos de anclaje. Disponibles herramientas de manipulación.

Tighten the M-12x140 screws. Drill holes in the paving (ø30x150) and fill with mortar or resin.

The template and anchoring bolts are supplied with the element. Tools available for handling.

Detalle técnico LED | LED technical detail

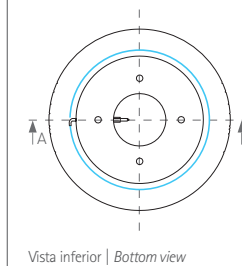

Vista inferior | Bottom view

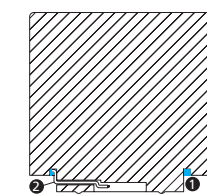

Sección AA | Section AA

- tira de LED flexible | flexible LED strip
- cable de conexión 2 x 0,5 mm² / connection cable 2 x 0,5 mm²

voltaje | voltage: 12 V
 medida LED | LED size: tira de | bande de 10 x 4 mm
 consumo por unidad | consumption per unit:
 circle puff ø45 x 45 cm: 6 W | circle puff ø60 x 50 cm: 8 W
 colores | colours: cyan, cold white and warm white
 tipo de LED | LED type: ecoLED TOP CHIP SMD

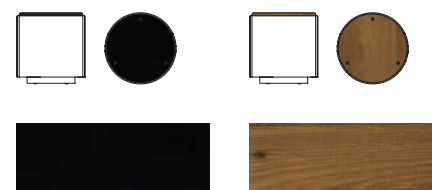

syntrewood®
 Reciclado a partir de residuos de los contenedores amarillos / Recycled using waste from yellow containers.

woody
 Laminado de alta presión (HPL) altamente resistente a la corrosión atmosférica / High Pressure Laminate (HPL) highly resistant to atmospheric corrosion.

square puff



Inspirada en nuestra actitud Mediterránea, es la pieza encontrada, un elemento de comunicación y de reunión. Aquella piedra utilizada como punto de apoyo estratégico para incentivar la relación humana, el juego, el diálogo y la relajación.

It's the perfect piece as an element of communication and as a meeting point inspired by our Mediterranean attitude. It can be used as a strategic support for promoting human relationships, conversation, game, dialogue and relaxation.

características characteristics



medidas | sizes:
45 x 45 x 45 cm

peso | weight:
180 Kg

acabado | finish:
SMOOTH

color | colour:

White, metal, fusion, black, basalt, red, yellow, blue

colocación | fixing:

Base fija. Anclado con tornillos | *Fixed base. Anchored with screws*

complementos | complements:

- Iluminación LED | *LED lighting*
- Material sostenible woody & syntrewood | *Sustainable material woody & syntrewood*

combinaciones combinations



material sostenible woody / sustainable material woody

opciones options

SEPARADORES METÁLICOS DECORATIVE METAL SPACER	
RUEDAS WHEELS	
LED LED	●
REFLECTANTE REFLECTING	
HIDRO HYDRO	
TAPA TOP	
ARO SUJETA BOLSA TASH BAG FIXING RING	
CENICERO ASHTRAY	
APOYABRAZOS ARMREST	
RESPALDO BACKREST	
MODULABLE MODULABLE	
WOODY/SYNTREWOOD	●

breinco Colors

SMOOTH

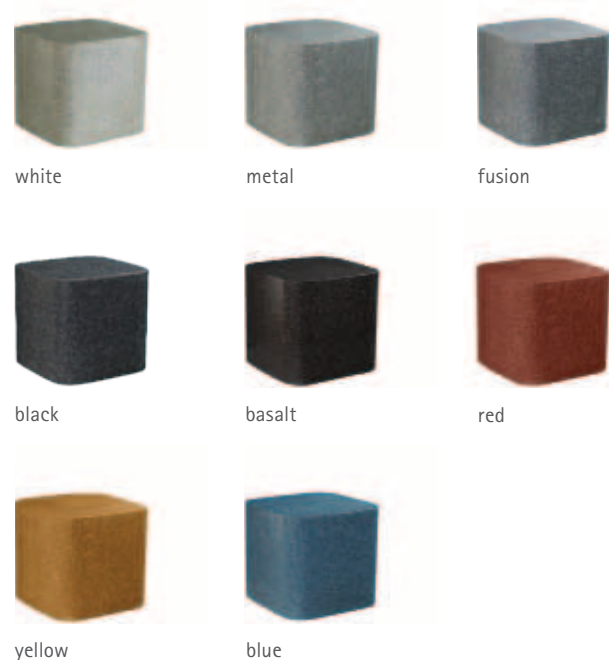

geometría geometry

ESCALA 0 CM 25 CM

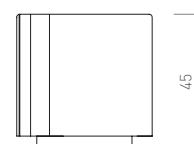

Frontal | Front view
Peso | Weight: 180 kg

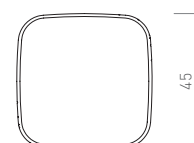

Planta | Plan view

Sección | Section

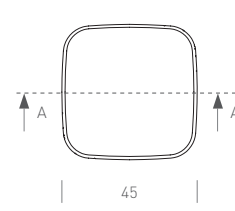

Planta | Plan view

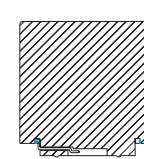

Sección AA | Section AA



syntrewood®
Reciclado a partir de residuos de los contenedores amarillos / Recycled using waste from yellow containers.

woody
Laminado de alta presión (HPL) altamente resistente a la corrosión atmosférica / High Pressure Laminate (HPL) highly resistant to atmospheric corrosion.

instalación installation

ELEVACIÓN | HOISTING (P/W=180 Kg.)

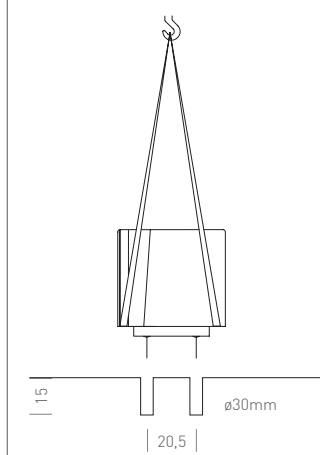

Roscar los tornillos M-12x140. Taladrar el pavimento (ø30x150) y llenar con mortero o resina.

Con el elemento se entregan la plantilla y los pernos de anclaje. Disponibles herramientas de manipulación.

Tighten the M-12x140 screws. Drill holes in the paving (ø30x150) and fill with mortar or resin.

The template and anchoring bolts are supplied with the element. Tools available for handling.

Detalle técnico LED | LED technical detail

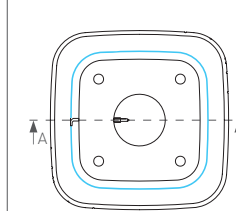

Vista inferior | Bottom view

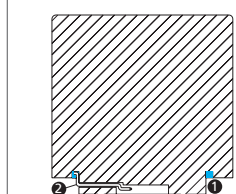

Sección AA | Section AA

- 1 tira de LED flexible / flexible LED strip
- 2 cable de conexión 2 x 0,5 mm² / connection cable 2 x 0,5 mm²

voltaje | voltage: 12 V

medida LED | LED size: tira de | bande de 10 x 4 mm

consumo por unidad | consumption per unit: 6 W

colores | colours: cyan, cold white and warm white

tipo de LED | LED type: ecoLED TOP CHIP SMD

rectangular bench

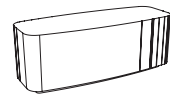

El elemento Rectangular Bench es una pieza monolítica que aporta un gran protagonismo al espacio y que se ha diseñado para convertirse en el complemento principal de la jardinera Rectangular Planter. Incorpora luz LED.

The Rectangular Bench is a monolithic piece which will become the centre of attention for any space in which it has been put and has been designed as the perfect accompaniment for the Rectangular Planter. It contains LED lighting.

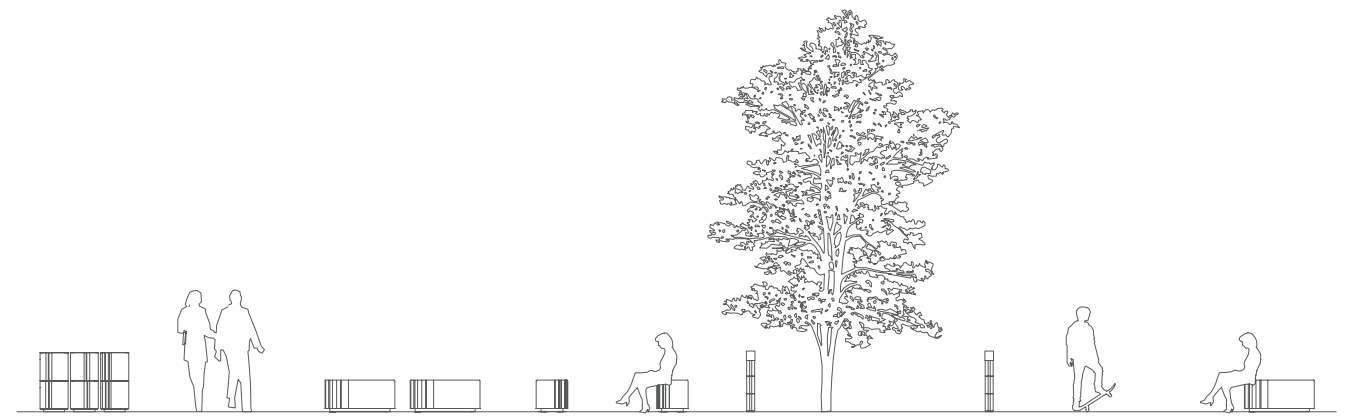

características characteristics



medidas | sizes:
100 x 44 x 45 cm

peso | weight:
447 Kg

acabado | finish:
SMOOTH

color | colour:
White, metal, fusion, black, basalt, red, yellow, blue

acabado | finish:

standard

color | colour:
Mediterráneo, ceniza, marfil, desierto, arena, cor-ten, metal, fusion, black

colocación | fixing:

Simplemente apoyado | Free-standing

complementos | complements:

- Iluminación LED | LED lighting
- Material sostenible woody | Sustainable material woody

combinaciones combinations



material sostenible woody / sustainable material woody

opciones options

SEPARADORES METÁLICOS DECORATIVE METAL SPACER	
RUEDAS WHEELS	
LED LED	●
REFLECTANTE REFLECTING	
HIDRO HYDRO	
TAPA TOP	
ARO SUJETA BOLSA TASH BAG FIXING RING	
CENICERO ASHTRAY	
APOYABRAZOS ARMREST	
RESPALDO BACKREST	
MODULABLE MODULABLE	
WOODY/SYNTREWOOD	●

breinco Colors

standard

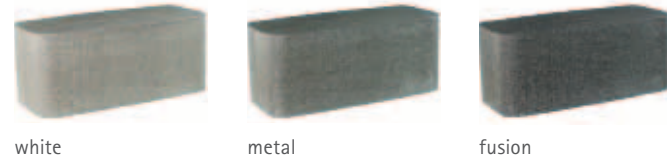
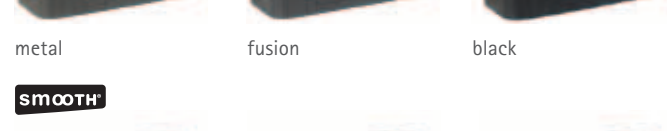
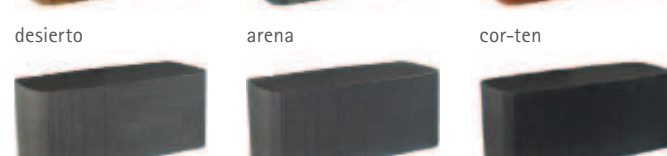

yellow blue

geometría geometry

ESCALA 0 CM 25 CM

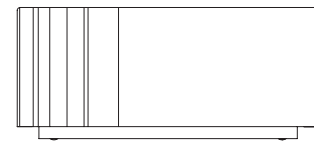

Frontal | Front view
Peso | Weight: 447 kg

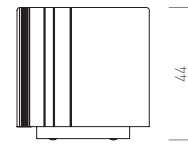

Lateral | Side view

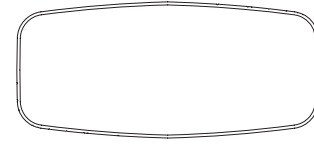

Planta | Plan view

Sección | Section

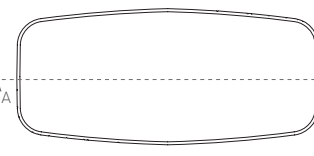

Planta | Plan view

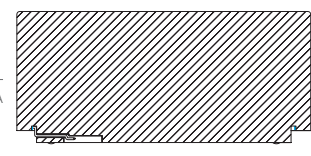

Sección AA | Section AA



woody
Laminado de alta presión (HPL) altamente resistente a la corrosión atmosférica / High Pressure Laminate (HPL) highly resistant to atmospheric corrosion.

instalación installation

ELEVACIÓN | HOISTING (PIW=447 Kg.)

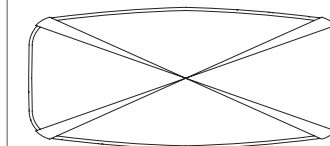
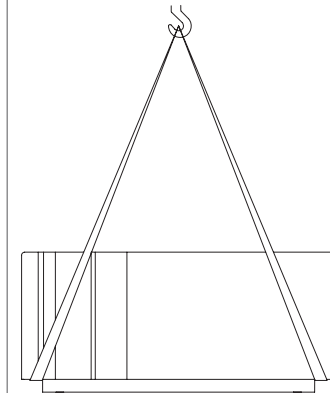

simplemente apoyado
free-standing

eslingas de poliéster
polyester slings

Detalle técnico LED | LED technical detail

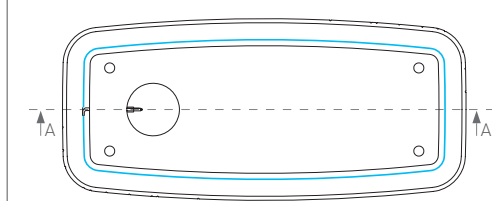

Vista inferior | Bottom view

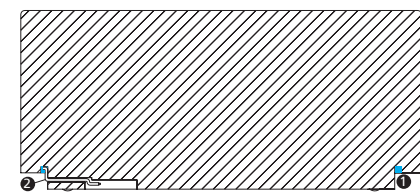

- 1 tira de LED flexible / flexible LED strip
- 2 cable de conexión 2 x 0,5 mm² / connection cable 2 x 0,5 mm²

Sección AA | Section AA

voltaje | voltage: 12 V

medida LED | LED size: tira de | bande de 10 x 4 mm

consumo por unidad | consumption per unit: 12 W

colores | colours: cyan, cold white and warm white

tipo de LED | LED type: ecoLED TOP CHIP SMD

stack

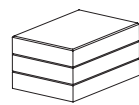

Una banqueta maciza de hormigón de alta calidad muy resistente a los ambientes agresivos. Por su gran resistencia puede usarse de límite o como protección. Es resistente al vandalismo y no tiene mantenimiento.

A solid seat bench made from high-quality concrete, resistant to extreme conditions. Due to its immense resistance it can be used to create a border or as protection. It is vandalism resistant and there is no maintenance.



características *characteristics*



medidas | *sizes*:
90 x 47 x 60 cm
 peso | *weight*:
560 Kg
 acabado | *finish*:
SMOOTH
 color | *colour*:
Mediterráneo, ceniza, marfil, desierto, arena, cor-ten, white, metal, fusion, black
 colocación | *fixing*:
Simplemente apoyado | *Free-standing*

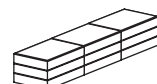

banco de 3 unidades
3 unit bench

270 x 47 x 60 cm

geometría *geometry*

ESCALA 0 CM 25 CM

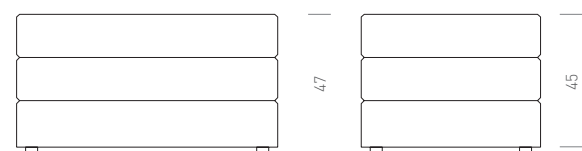

Frontal | *Front view*
 Peso | *Weight*: 560 kg

Lateral | *Side view*



Planta | *Plan view*

instalación *installation*

ELEVACIÓN | *HOISTING* (PIW=560 Kg.)

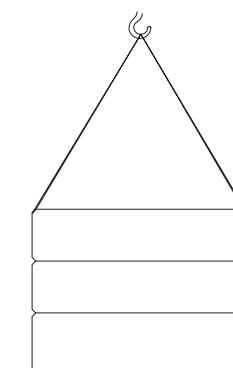
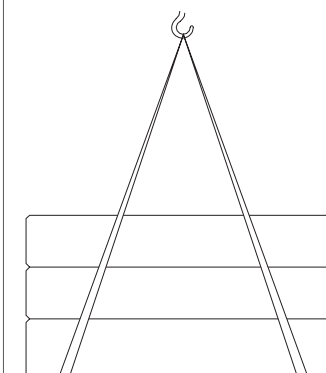

simplemente apoyado
free-standing

eslingas de poliéster
polyester slings

combinaciones *combinations*



3 colores: black, white, black /
3 colours: black, white, black

opciones *options*

SEPARADORES METÁLICOS DECORATIVE METAL SPACER	
RUEDAS WHEELS	
LED	
REFLECTANTE REFLECTING	
HIDRO HYDRO	
TAPA TOP	
ARO SUJETA BOLSA TASH BAG FIXING RING	
CENICERO ASHTRAY	
APOYABRAZOS ARMREST	
RESPALDO BACKREST	
MODULABLE MODULABLE	●
WOODY/SYNTREWOOD	

breinco *Colors*

SMOOTH



mediterráneo



ceniza



marfil



desierto



arena



cor-ten



white



metal



fusion



black

lounge

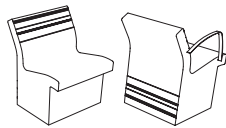

Una silla "para sentarse bien", de forma simple y anatómica. Sentarse con una posición de confort ayuda a tener una buena predisposición a relacionarnos. La silla actúa como las mismas personas, de forma individual, o creando grupos sociales.

A chair that makes it easy "to sit well" in the anatomically correct position. Sitting in a comfortable position increases our predisposition towards positive interactions with others. The chair works just like people: individually or creating social groups.

características characteristics



medidas | sizes: 55 x 76,2 x 64,6 cm peso | weight: 287 Kg

acabado | finish: **SMOOTH**

color | colour:

White, metal, fusion, black, basalt, red, yellow, blue

color apoyabrazos | armrest colour:

Matte stainless steel, black 9005, white 9003

colocación | fixing:

Base fija. Anclado con tornillos | Fixed base. Anchored with screws

personalizable | customization:

• Grabado | Engraving

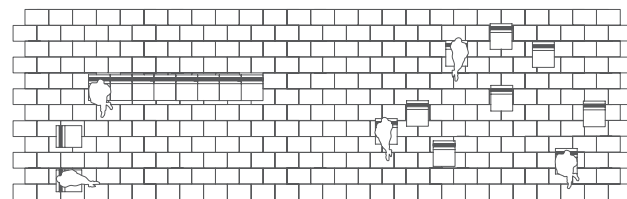

Planta | Plan view

combinaciones combinations

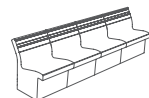

banco de 4 unidades
4 unit bench

222 x 76,4 x 64,6 cm

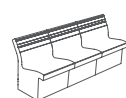

banco de 3 unidades
3 unit bench

166 x 76,4 x 64,6 cm



banco de 2 unidades
2 unit bench

110 x 76,4 x 64,6 cm

opciones options

SEPARADORES METÁLICOS DECORATIVE METAL SPACER	●
RUEDAS WHEELS	
LED	
REFLECTANTE REFLECTING	
HIDRO HYDRO	
TAPA TOP	
ARO SUJETA BOLSA TASH BAG FIXING RING	
CENICERO ASHTRAY	
APOYABRAZOS ARMREST	●
RESPALDO BACKREST	
MODULABLE MODULABLE	●
WOODY/SYNTREWOOD	

breinco Colors

SMOOTH



white



metal



fusion



black



basalt



red



yellow



blue

geometría geometry

ESCALA 0 CM 50 CM



Frontal | Front view
Peso | Weight: 287 kg

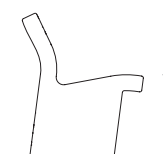

Lateral | Side view

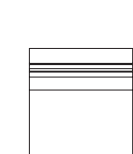

Planta | Plan view

1 apoyabrazos | 1 armrest

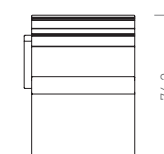

Frontal | Front view
Peso | Weight: 289 kg

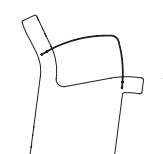

Lateral | Side view

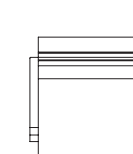

Planta | Plan view

2 apoyabrazos | 2 armrest

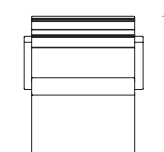

Frontal | Front view
Peso | Weight: 291 kg

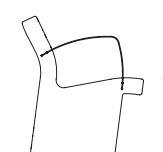

Lateral | Side view

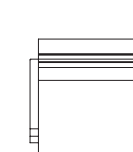

Planta | Plan view

banco de 4 unidades | 4 unit bench

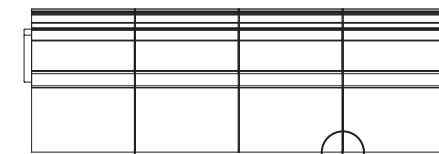

Frontal | Front view
Peso | Weight: 1157 kg

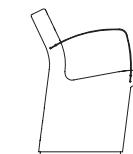

Lateral | Side view

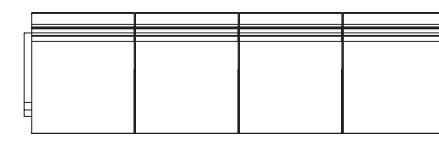

Planta | Plan view

instalación installation

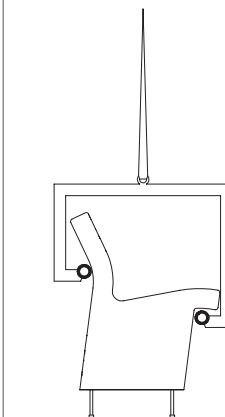

Roscar los tornillos M-12x140. Taladrar el pavimento (ø30x150) y llenar con mortero o resina.

Con el elemento se entregan la plantilla y los pernos de anclaje. Disponibles herramientas de manipulación.



Tighten the M-12x140 screws. Drill holes in the paving (ø30x150) and fill with mortar or resin.

The template and anchoring bolts are supplied with the element. Tools available for handling.

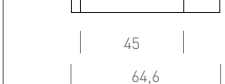
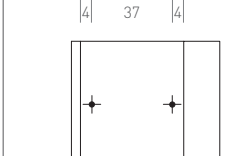

lounge light

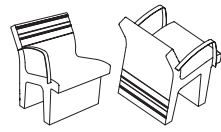

La modularidad de la pieza nos aporta la posibilidad de crear espacio, de contener o de crear un banco lineal. Consta de un amplio programa de complementariedades de color y posibilidades de combinaciones que forman el rasgo distintivo de esta silla, banco o bancada.

The chair's modular nature means it can be used to create spaces, delimit spaces or form a linear bench. It features a complex program of coloured accessories and potential combinations, making it the distinctive characteristic of this chair or bench.

características characteristics



medidas | sizes:

55 x 76,2 x 64,6 cm

peso | weight:

175 Kg

acabado | finish:

SMOOTH

color | colour:

White, metal, fusion, black, basalt, red, yellow, blue

color apoyabrazos | armrest colour:

Matte stainless steel, black 9005, white 9003

colocación | fixing:

Base fija. Anclado con tornillos | Fixed base. Anchored with screws

personalizable | customization:

• Grabado | Engraving

complementos | complements:

• Iluminación LED | LED lighting

combinaciones combinations

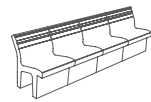

banco de 4 unidades
4 unit bench

222 x 76,4 x 64,6 cm

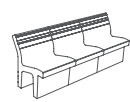

banco de 3 unidades
3 unit bench

166 x 76,4 x 64,6 cm

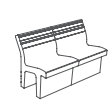

banco de 2 unidades
2 unit bench

110 x 76,4 x 64,6 cm

opciones options

SEPARADORES METÁLICOS DECORATIVE METAL SPACER	●
RUEDAS WHEELS	
LED	●
REFLECTANTE REFLECTING	
HIDRO HYDRO	
TAPA TOP	
ARO SUJETA BOLSA TASH BAG FIXING RING	
CENICERO ASHTRAY	
APOYABRAZOS ARMREST	●
RESPALDO BACKREST	
MODULABLE MODULABLE	●
WOODY/SYNTREWOOD	

breinco Colors

SMOOTH



white



metal



fusion



black



basalt



red



yellow



blue

geometría geometry

ESCALA 0 CM 25 CM

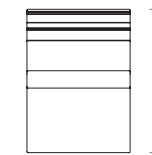

Frontal | Front view
Peso | Weight: 175 kg

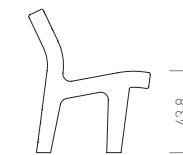

Lateral | Side view

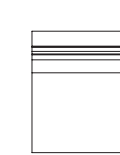

Planta | Plan view

1 apoyabrazos | 1 armrest

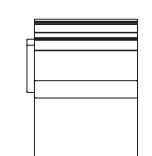

Frontal | Front view
Peso | Weight: 177 kg

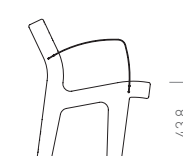

Lateral | Side view

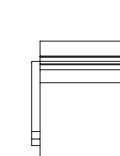

Planta | Plan view

2 apoyabrazos | 2 armrest

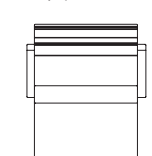

Frontal | Front view
Peso | Weight: 179 kg

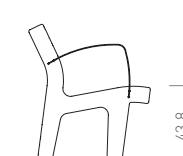

Lateral | Side view

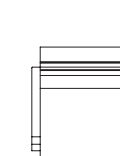

Planta | Plan view

banco de 4 unidades | 4 unit bench

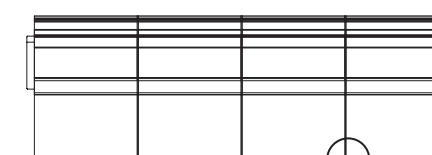

Frontal | Front view
Peso | Weight: 709 kg



Lateral | Side view

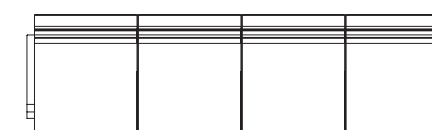

Planta | Plan view

instalación installation

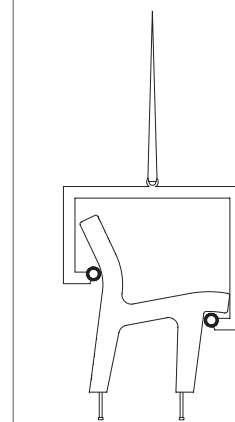

Roscar los tornillos M-12x140. Taladrar el pavimento (ø30x150) y llenar con mortero o resina.

Con el elemento se entregan la plantilla y los pernos de anclaje. Disponibles herramientas de manipulación.

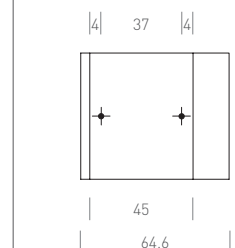
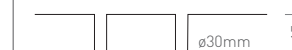

Tighten the M-12x140 screws. Drill holes in the paving (ø30x150) and fill with mortar or resin.

The template and anchoring bolts are supplied with the element. Tools available for handling.

Detalle técnico LED | LED technical detail

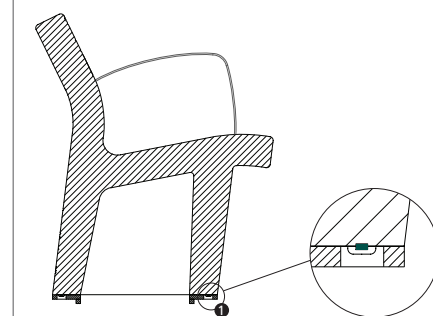

Sección | Section

● tira de LED de 10 x 4mm / strap LED of 10x3mm

voltaje | voltage: 12 V

medida LED | LED size: tira de | bande de 10 x 4 mm

consumo por unidad | consumption per unit: 5 W

consumo banco 4 unidades | consumption 4 unit bench: 20 W

colores | colours: cyan, cold white and warm white

tipo de LED | LED type: ecoLED TOP CHIP SMD

lounge fly

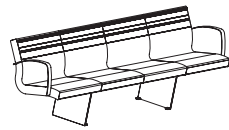

Banco de 2,22m de longitud, de diseño anatómico y posición de confort. Es la evolución de las sillas Lounge llevadas a la simplificación mediante dos puntos de apoyo metálicos que le aportan esbeltez.

Bench of 2.22 m in length, anatomic design and position of comfort. Is the evolution of Lounge chairs taken to simplification by two metal supports that give slimness.

características characteristics

- medidas | sizes:
222 x 76,2 x 64,2 cm
- peso | weight:
423 Kg
- acabado | finish:
SMOOTH
- color | colour:
White, metal, fusion, black, basalt, red, yellow, blue
- color soporte | support colour:
Galvanised, matte stainless steel
- color apoyabrazos | armrest colour:
Matte stainless steel, black 9005, white 9003
- colocación | fixing:
Base fija. Anclado con tornillos | Fixed base. Anchored with screws
- personalización | customization:
• Grabado | Engraving



combinaciones combinations



apoyabrazos black 9005 / black 9005 armrest

opciones options

SEPARADORES METÁLICOS DECORATIVE METAL SPACER	●
RUEDAS WHEELS	
LED	
REFLECTANTE REFLECTING	
HIDRO HYDRO	
TAPA TOP	
ARO SUJETA BOLSA TASH BAG FIXING RING	
CENICERO ASHTRAY	
APOYABRAZOS ARMREST	●
RESPALDO BACKREST	
MODULABLE MODULABLE	●
WOODY/SYNTREWOOD	

breinco Colors

SMOOTH



geometría geometry

ESCALA 0 CM 50 CM



Frontal | Front view
Peso | Weight: 423 kg

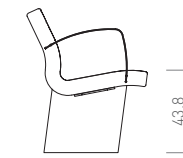

Lateral | Side view

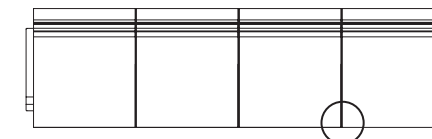

Planta | Plan view

instalación installation

ELEVACIÓN | HOISTING (P|W=423 Kg.)

Opción 1 | Option 1

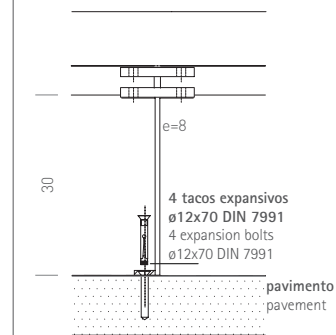
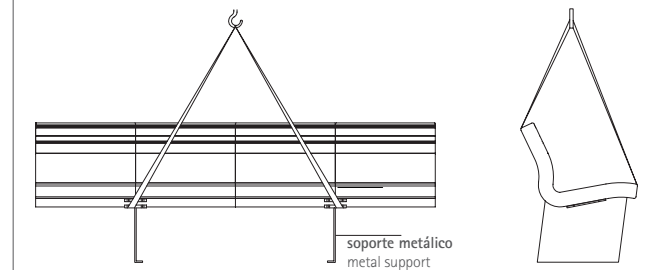

Taladrar el pavimento (Ø12 x 80) y roscar los tacos expansivos (Ø12 x 70) con una llave Allen.

Con el elemento se entregan los tacos expansivos y la llave Allen.

Drill holes in the paving (Ø12 x 80) and tighten the expansion bolts (Ø12 x 70) with an Allen key.

The expansion bolts and the Allen key are supplied with the element.

Opción 2 | Option 2: anclado en base de hormigón | anchored in concrete base

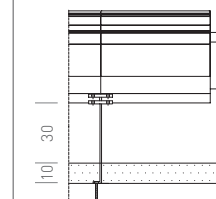

pause

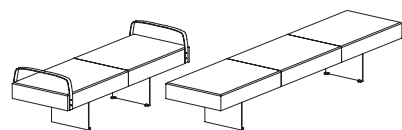

Banco de líneas simples y apariencia ligera que se convierte en un punto de encuentro. Una gran losa que se apoya sobre ligeros soportes metálicos y que invita a detenerse. Una pieza de gran funcionalidad de acabado liso, suave al tacto y que consigue un brillo mate especial.

Bench with simple lines and lightweight appearance that turns into a meeting point. A large tile that rests on light metal supports that invites to stop. A highly functional piece of smooth finish, soft to touch and with a special matt shine.

características characteristics



medidas | sizes: 175 x 45 x 60 cm 262,5 x 45 x 60 cm

peso | weight: 400 Kg 600 Kg

acabado | finish: **SMOOTH**

color | colour: Mediterráneo, ceniza, marfil, desierto, arena, cor-ten, white, metal, fusion, black, basalt, red, yellow, blue

color soporte | support colour: Galvanised, matte stainless steel

color apoyabrazos | armrest colour: Matte stainless steel, black 9005, white 9003

colocación | fixing: Base fija. Anclado con tornillos | Fixed base. Anchored with screws

personalización | customization: Grabado | Engraving

complementos | complements: Respaldo de madera tropical | Tropical wood backrest

combinaciones combinations



apoyabrazos white 9003 / white 9003 armrest

opciones options

SEPARADORES METÁLICOS DECORATIVE METAL SPACER	
RUEDAS WHEELS	
LED	
REFLECTANTE REFLECTING	
HIDRO HYDRO	
TAPA TOP	
ARO SUJETA BOLSA TASH BAG FIXING RING	
CENICERO ASHTRAY	
APOYABRAZOS ARMREST	●
RESPALDO BACKREST	●
MODULABLE MODULABLE	●
WOODY/SYNTREWOOD	

breinco Colors

SMOOTH

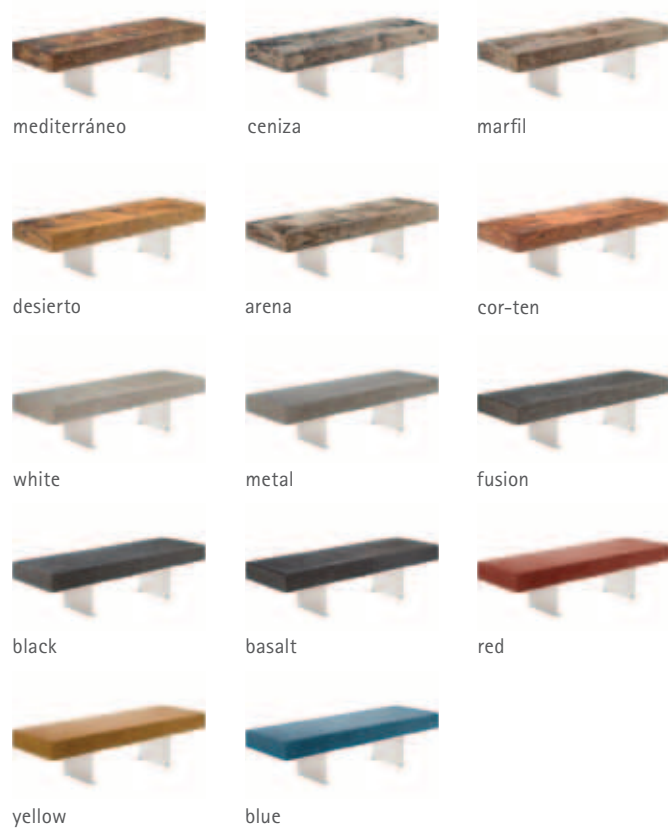

geometría geometry

ESCALA 0 CM 50 CM

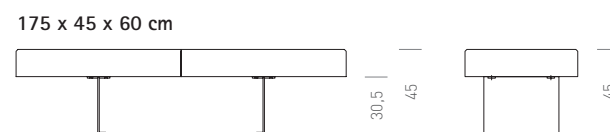

Frontal | Front view
Peso | Weight: 400 kg



Planta | Plan view

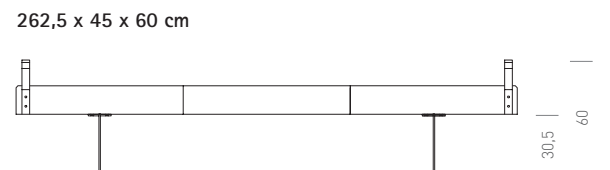

Frontal | Front view
Peso | Weight: 600 kg

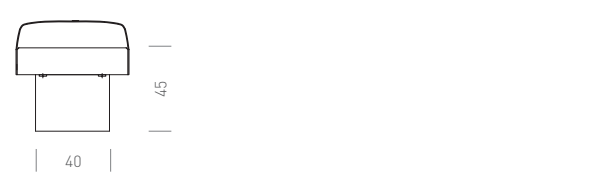

Lateral | Side view

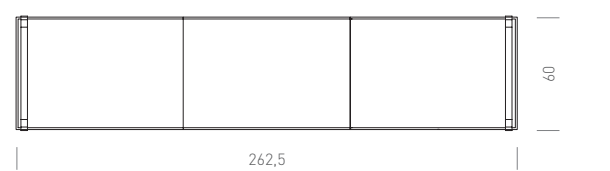

Planta | Plan view

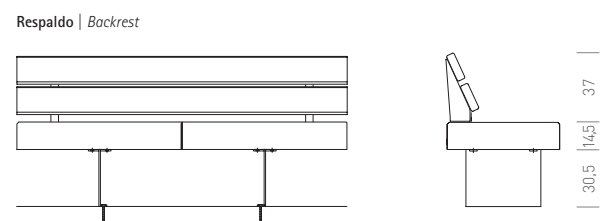

Frontal | Front view

Lateral | Side view

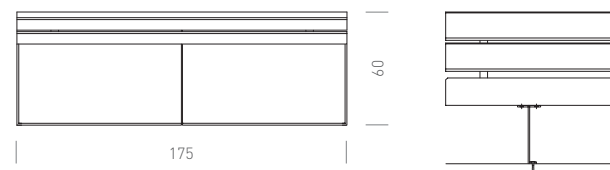

Planta | Plan view

Frontal | Front view
Longitud 262,5 cm | Length 262,5 cm

instalación installation

ELEVACIÓN | HOISTING (P)W=400 Kg.

Opción 1 | Option 1

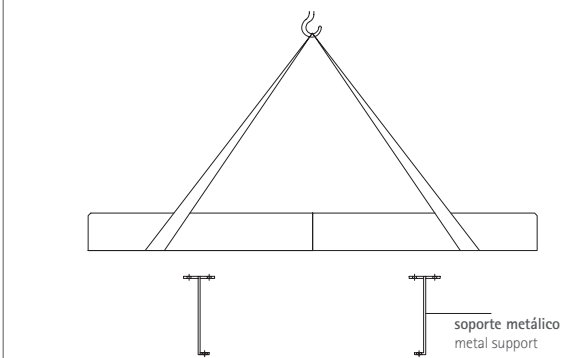

Atornillar el soporte metálico con los tornillos M-12 x 16 al banco y atornillar los tacos expansivos (ø12 x 70) al pavimento.

Con el elemento se entregan los tornillos, los tacos expansivos y la llave Allen.

Fasten the metal support to the bench with the M-12 x 16 screws. Select the bench position and screw the expansion bolts (ø12 x 70) to the paving.

The screws, expansion bolts and Allen key are supplied with the element.

Opción 2 | Option 2: anclado en base de hormigón | anchored in concrete base

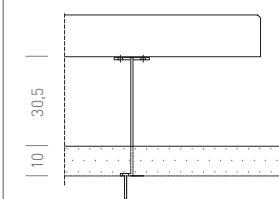

pause side

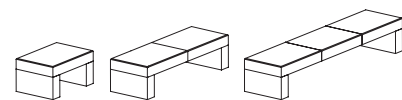

Banco de líneas simples apoyado en los extremos por dos soportes laterales. Un banco de hormigón de alta calidad muy resistente a los ambientes agresivos. La posibilidad de longitudes importantes permite su integración en grandes espacios.

Simple, linear bench supported at each end by two side supports. A bench made from high-quality concrete, resistant to extreme conditions. The option to have long lengths means it can be incorporated into large spaces.



características characteristics



medidas | sizes:
90 x 45 x 60 cm 175 x 45 x 60 cm 262,5 x 45 x 60 cm

peso | weight:
300 Kg 500 Kg 700 Kg

acabado | finish:

SMOOTH

color | colour:

Mediterráneo, ceniza, marfil, desierto, arena, cor-ten, white, metal, fusion, black

color soporte | support colour:

Matte stainless steel, black 9005, white 9003

colocación | fixing:

Simplemente apoyado | Free-standing

personalización | customization:

• Grabado | Engraving

geometría geometry

ESCALA 0 CM 50 CM

90 x 45 x 60 cm

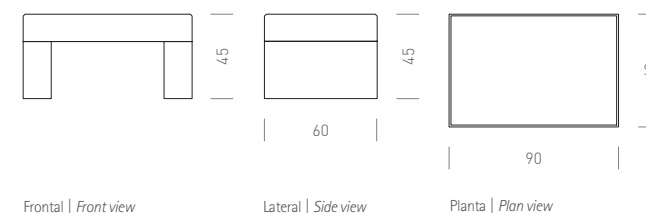

Frontal | Front view
Peso | Weight: 300 kg

Lateral | Side view

Planta | Plan view

175 x 45 x 60 cm

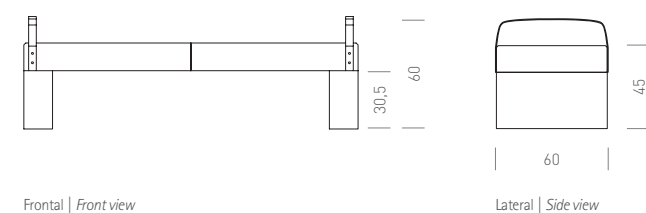

Frontal | Front view
Peso | Weight: 500 kg

Lateral | Side view

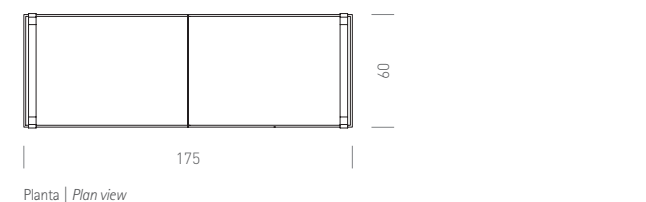

Planta | Plan view

262,5 x 45 x 60 cm

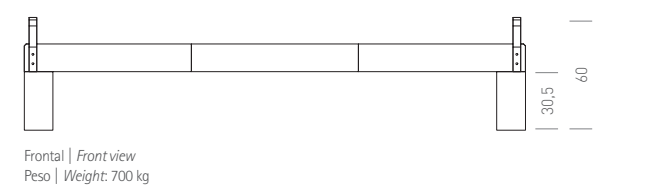

Frontal | Front view
Peso | Weight: 700 kg

Lateral | Side view

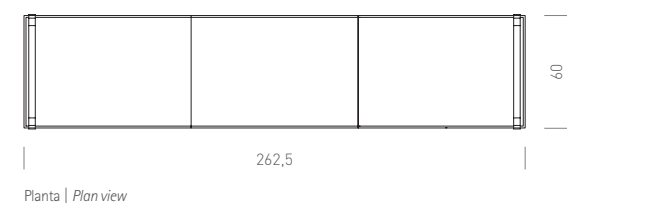

Planta | Plan view

instalación installation

ELEVACIÓN | HOISTING (P/W=300/708 Kg.)

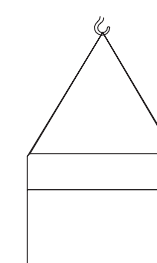
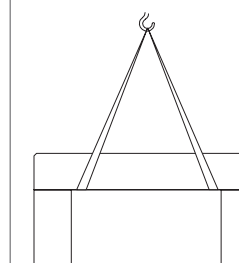

simplemente apoyado
free-standing

eslingas de poliéster
polyester slings

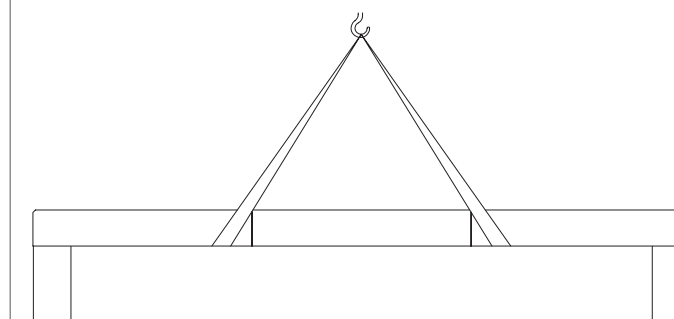

Elevar el banco mediante eslingas colocadas en los puntos indicados, sin retirar las cantoneras. Colocarlo en la posición deseada. El banco sólo va apoyado, no lleva ningún tipo de anclaje.

Lift the bench using the slings placed where indicated without removing the protection. Place the bench in the desired position. It should be positioned and does not have any type of attachment mechanism.

combinaciones combinations



apoyabrazos white 9003 / white 9003 armrest

opciones options

SEPARADORES METÁLICOS DECORATIVE METAL SPACER	
RUEDAS WHEELS	
LED	
REFLECTANTE REFLECTING	
HIDRO HYDRO	
TAPA TOP	
ARO SUJETA BOLSA TASH BAG FIXING RING	
CENICERO ASHTRAY	
APOYABRAZOS ARMREST	●
RESPALDO BACKREST	
MODULABLE MODULABLE	●
WOODY/SYNTREWOOD	

breinco Colors

SMOOTH



mediterráneo



ceniza



marfil



desierto



arena



cor-ten



white



metal



fusion



black

pause central

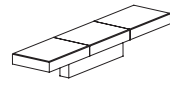

Banco con una geometría de sección rectangular que se apoya en un pie central a modo de peana. Un banco de hormigón de alta calidad resistente a los ambientes agresivos.

Bench with rectangular section geometry that is supported by a central base. A bench made from high-quality concrete, resistant to extreme conditions.

características *characteristics*

medidas | *sizes:*
262,5 x 45 x 60 cm
peso | *weight:*
700 Kg
acabado | *finish:*

SMOOTH

color | *colour:*
Mediterráneo, ceniza, marfil, desierto, arena, cor-ten, white, metal, fusion, black

color apoyabrazos | *armrest colour:*
Matte stainless steel, black 9005, white 9003

colocación | *fixing:*
Base fija. Anclado con tornillos | *Fixed base. Anchored with screws*

personalización | *customization:*
• Grabado | *Engraving*



geometría *geometry*

ESCALA 0 CM 50 CM

262,5 x 45 x 60 cm

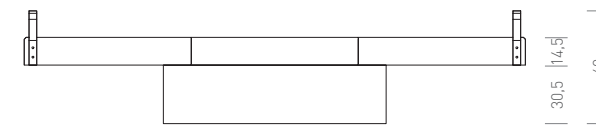

Frontal | *Front view*
Peso | *Weight:* 700 kg



Lateral | *Side view*

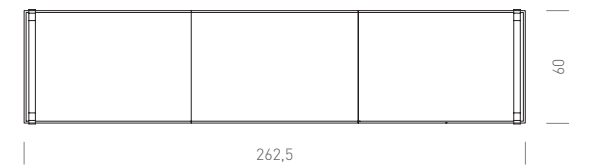

Planta | *Plan view*

instalación *installation*

ELEVACIÓN | *HOISTING* (P=600 Kg.)

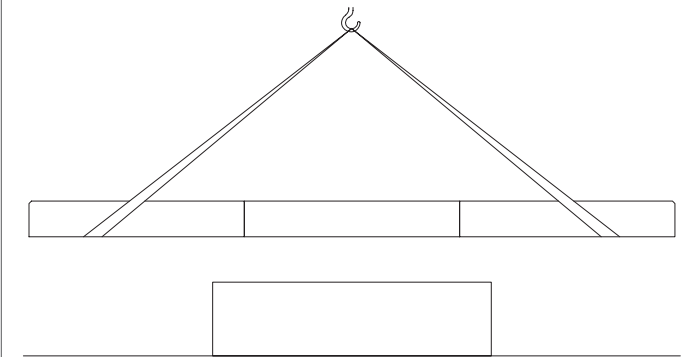

Frontal | *Front view*

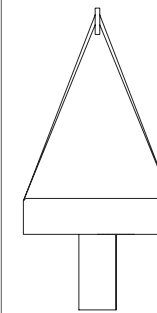

Lateral | *Side view*

1. Atornillar las varillas roscadas M20 (suministradas) al pie del banco.
2. Fijar el pie de hormigón al pavimento introduciendo las varillas roscadas M20 en un agujero de ø30 lleno de resina o mortero.
3. Elevar el banco mediante eslingas y por los puntos indicados y posicionarlo sobre el pie de hormigón.
4. Atornillar los 4 tornillos M12x30 (suministrados) uniendo la pletina del pie de hormigón al banco.

1. Tighten M20 threaded rod (supplied).
2. Fixing the concrete base to the paving introducing M20 threaded rod in a ø30 hole fill with mortar or resin.
3. Raise the bench by slings placed at the points indicated and place it over the concrete food.
4. Tighten the M12x30 screws (supplied) joining the plate on the base to the bench.

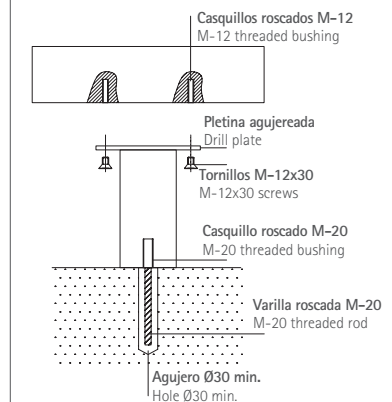

combinaciones *combinations*



apoyabrazos white 9003 / white 9003 armrest

opciones *options*

SEPARADORES METÁLICOS DECORATIVE METAL SPACER	
RUEDAS WHEELS	
LED	
REFLECTANTE REFLECTING	
HIDRO HYDRO	
TAPA TOP	
ARO SUJETA BOLSA TASH BAG FIXING RING	
CENICERO ASHTRAY	
APOYABRAZOS ARMREST	●
RESPALDO BACKREST	
MODULABLE MODULABLE	●
WOODY/SYNTREWOOD	

breinco *Colors*

SMOOTH



pause wood

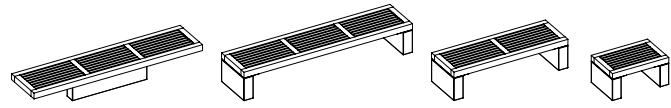

El Pause Wood convive con la familia de los Pause manteniendo la geometría y las características que lo definen: solidez y calidad. El resultado son unos bancos con soportes de hormigón y asiento de madera que permiten la misma modulación que el banco Pause originario y amplían la familia con nuevas aplicaciones: se convierte en un banco amable y cálido que abre la puerta a ser utilizado en interiores.

Pause Wood is part of the Pause range, keeping the same shape, lines and features that define it: solidity and quality. The result is a bench with concrete legs and a wooden seat that allows for the same assembly as the original Pause bench, extending the range with its new uses: it can become a nice bench giving warmth to indoor spaces.

características characteristics



medidas | sizes:

- Pause wood side: 260 x 45 x 60 cm
- Pause wood side: 180 x 45 x 60 cm
- Pause wood side: 90 x 45 x 60 cm
- Pause wood central: 260 x 45 x 60 cm

peso | weight:

- Pause wood side L=260cm: 180 kg
- Pause wood side L=180cm: 170 kg
- Pause wood side L=90cm: 160 kg
- Pause wood central L=260cm: 170 kg

estructura | structure:

Listones de madera termotratada | *Thermo-treated wooden slats*

acabado | finish:

SMOOTH

couleur | colour:

white, metal, fusion, black

pose | fixing:

Base fija. Anclada con tornillos | *Fixed base. Anchored with screws*

combinaciones combinations

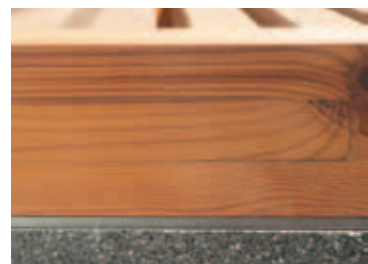

Listones de madera europea termotratada | *Thermo-treated wooden slats.*
Estructura color black / *Black coloured structure.*

opciones options

SEPARADORES METÁLICOS DECORATIVE METAL SPACER	
RUEDAS WHEELS	
LED	
REFLECTANTE REFLECTING	
HIDRO HYDRO	
TAPA TOP	
ARO SUJETA BOLSA TASH BAG FIXING RING	
CENICERO ASHTRAY	
APOYABRAZOS ARMREST	●
RESPALDO BACKREST	
MODULABLE MODULABLE	●
WOODY/SYNTREWOOD	

breinco Colors

SMOOTH

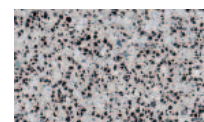

white

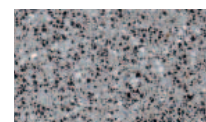

metal

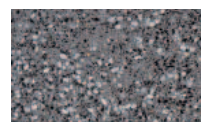

fusion

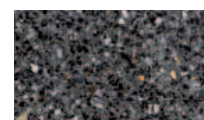

black

listones | slats:

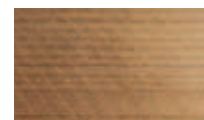

europea | *European*

Madera europea termotratada con certificación FSC
FSC Certified European thermo-treated wood



geometría geometry

ESCALA 0 CM 50 CM

Pause wood side
260 x 45 x 60 cm

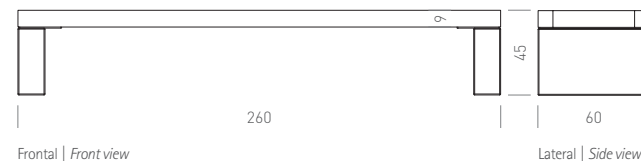

Frontal | *Front view*
Peso | *Weight:* 180 kg

Lateral | *Side view*

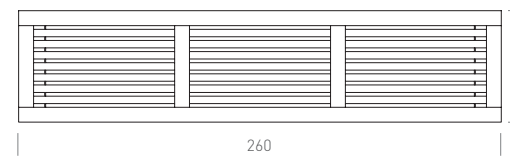

Planta | *Plan view*

90 x 45 x 60 cm

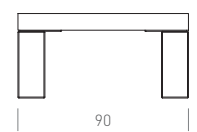

Frontal | *Front view*
Peso | *Weight:* 160 kg

180 x 45 x 60 cm



Frontal | *Front view*
Peso | *Weight:* 170 kg

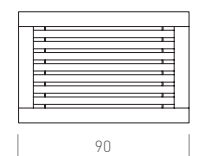

Planta | *Plan view*

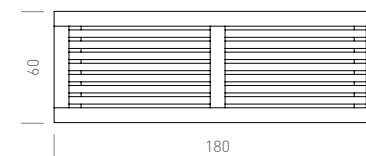

Planta | *Plan view*

Pause wood central
260 x 45 x 60 cm

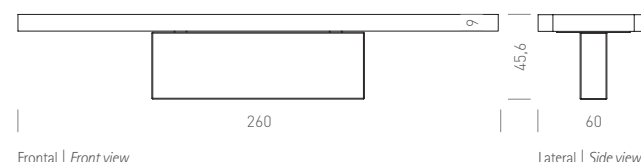

Frontal | *Front view*
Peso | *Weight:* 170 kg

Lateral | *Side view*

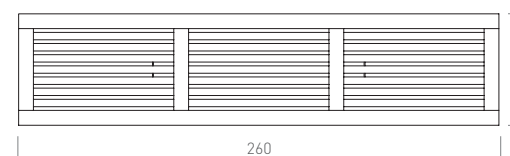

Planta | *Plan view*

instalación installation

Pause wood side
90 x 45 x 60 cm | 180 x 45 x 60 cm | 260 x 45 x 60 cm

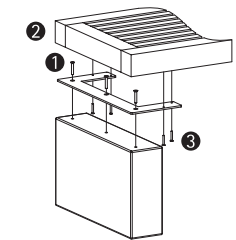

Pause wood central
260 x 45 x 60 cm

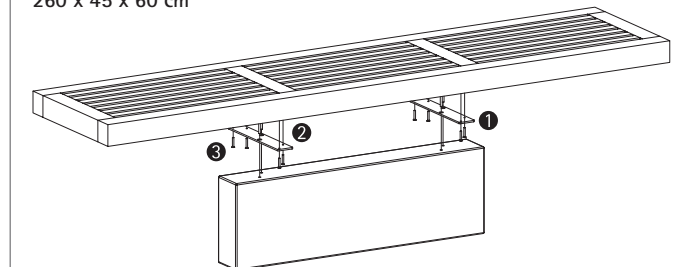

1. Roscar los soportes metálicos a los pies de hormigón mediante tornillos avellanados M10.
2. Colocar la madera de forma que coincidan los orificios de los soportes metálicos con los orificios preagujereados de la madera.
3. Unir el pie a la bacada de madera roscando los tornillos para madera.

1. Screw the metal brackets into the concrete legs using M10 countersunk screws.
2. Line up the wood so that the holes of the metal brackets align with the pre-drilled holes in the wood.
3. Screw the foot of the bench to the wood using woodscrews.

Base fija. Anclada con tornillos
Fixed base. Anchored with screws

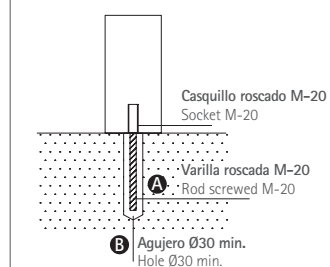

- A. Atornillar las varillas roscadas M20 (suministradas) al pie del banco.
 - B. Fijar el pie de hormigón al pavimento introduciendo las varillas roscadas M20 en un agujero de Ø30 lleno de resina o mortero.
- A. Tighten M20 threaded rod (supplied).
B. Fixing the concrete base to the paving introducing M20 threaded rod in a Ø30 hole fill with mortar or resin.

basic 50

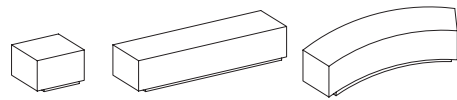

Es la versión menos pesada de la línea monolítica básica. Más versatilidad y menos peso. Además del banco recto y el puff, la línea Basic50 ofrece la posibilidad de formas curvas combinando el mismo banco hasta construir un círculo completo. También existe la opción de fabricarlo 15 cm más alto para encastarlo en el terreno a modo de muro jardinera.

This is the lighter version of the basic monolithic line. It is more versatile and weighs less. In addition to a straight bench and puff bench, the Basic50 line can also create curved benches, as well as a completely circular bench. There is also the option to build it 15cm taller in order to build it into the ground to form a type of garden wall.

características characteristics



medidas | sizes:

140 x 46 x 50 cm
50 x 46 x 50 cm
R 140 x 46 x 50 cm

peso | weight:

140 x 46 x 50 cm: 760 kg
50 x 46 x 50 cm: 270 kg
R 140 x 46 x 50 cm: 905 kg

acabado | finish:

SMOOTH STRIP

color | colour:

White, grey, black, beige

chaflán | chamfer:

10 mm | 10 mm

colocación | fixing:

Base fija. Anclado con tornillos | Fixed base. Anchored with screws

combinaciones combinations

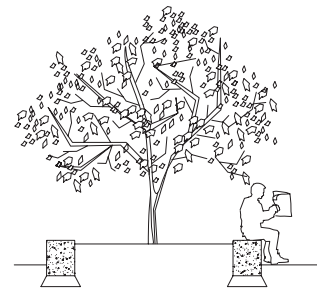

Opción 2: anclado en el terreno / Option 2: anchored into the ground

opciones options

SEPARADORES METÁLICOS DECORATIVE METAL SPACER	
RUEDAS WHEELS	
LED	
REFLECTANTE REFLECTING	
HIDRO HYDRO	
TAPA TOP	
ARO SUJETA BOLSA TASH BAG FIXING RING	
CENICERO ASHTRAY	
APOYABRAZOS ARMREST	●
RESPALDO BACKREST	●
MODULABLE MODULABLE	●
WOODY/SYNTREWOOD	

breinco Colors

SMOOTH



white wet



grey wet



black wet



beige wet

STRIP



white wet

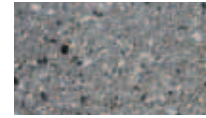

grey wet



black wet



beige wet

geometría geometry

ESCALA 0 CM 50 CM

50 x 46 x 50 cm

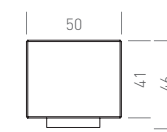

Frontal | Front view
Peso | Weight: 270 kg

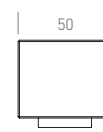

Lateral | Side view

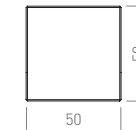

Planta | Plan view

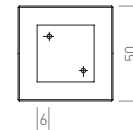

Planta inferior | Bottom view

140 x 46 x 50 cm

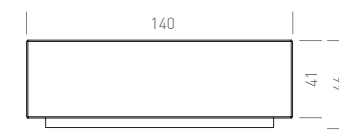

Frontal | Front view
Peso | Weight: 760 kg

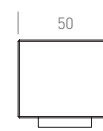

Lateral | Side view



Planta | Plan view

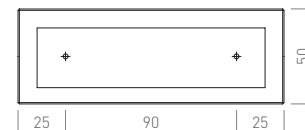

Planta inferior | Bottom view

R140 x 46 x 50 cm

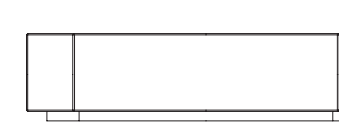

Frontal | Front view
Peso | Weight: 905 kg

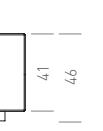

Lateral | Side view

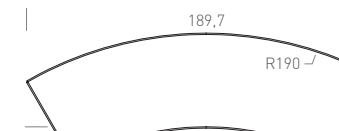

Planta | Plan view

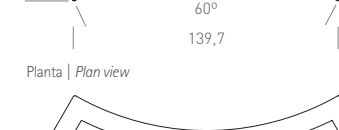

Planta inferior | Bottom view

instalación installation

50 x 46 x 50 cm

Eslingas de poliéster.
Polyester slings.

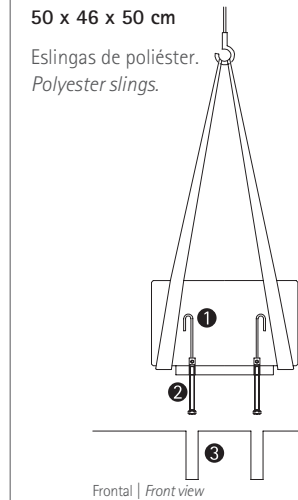

Frontal | Front view

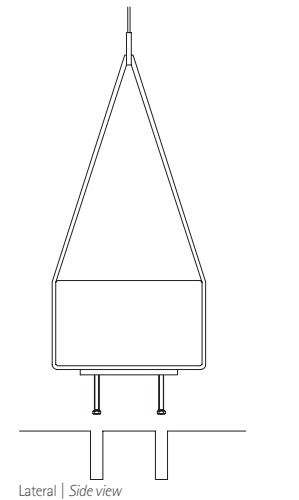

Lateral | Side view

140 x 46 x 50 cm
R140 x 46 x 50 cm

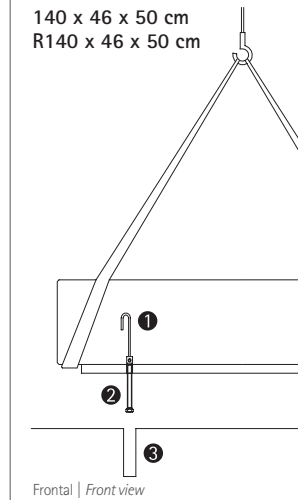

Frontal | Front view

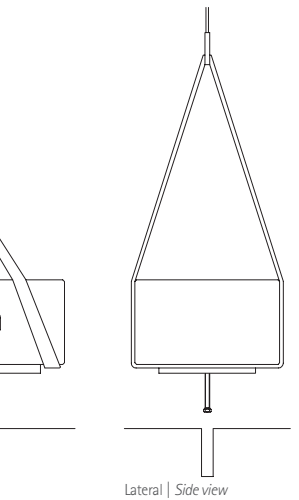

Lateral | Side view

1. Casquillos roscados M16 embebidos.
2. Tornillos M16 x 140.
3. Taladrar el pavimento (ø 50 x 180) y llenar con resina o mortero rico.

1. Socket M16
2. Screws M16 x 140.
3. Drill pavement (ø 50 x 180) and fill with resin or fat mortar.

basic 60

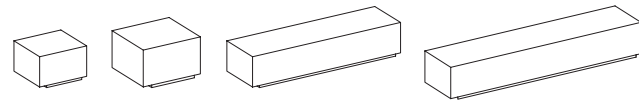

Línea básica monolítica de hormigón con dos acabados: liso y texturado. Una pieza simple pero robusta de gran versatilidad que se adapta a las características de cada lugar, del más urbano al más virgen. Admite una limpieza enérgica gracias a la durabilidad y la resistencia del material, propiedades necesarias para aumentar la calidad y el confort.

Basic monolithic concrete line with two finishes: smooth and textured. A simple yet resilient stone, which is versatile, adapting to its surroundings whether they be urban or rural. It can be exposed to rigorous cleaning thanks to the durability and robust nature of the material, essential for better quality and convenience.

características characteristics



medidas | sizes:
 340 x 46 x 60 cm
 240 x 46 x 60 cm
 60 x 46 x 60 cm
 120 x 46 x 120 cm
 peso | weight:
 340 x 46 x 60 cm: 2145 kg
 240 x 46 x 60 cm: 1510 kg
 60 x 46 x 60 cm: 390 kg
 120 x 46 x 120 cm: 1570 kg

acabado | finish:
SMOOTH **STRIP**
 color | colour:
 White, grey, black, beige
 chaflán | chamfer:
 10 mm | 10 mm
 colocación | fixing:
 Anclado con tornillos | Anchored with screws
 120x46x120: Simplemente apoyado | Free-standing

combinaciones combinations



Combinación Basic 50 y Basic 60 con faldón de madera (con o sin respaldo) | Basic 50 and Basic 60 combination

opciones options

SEPARADORES METÁLICOS DECORATIVE METAL SPACER	
RUEDAS WHEELS	
LED	
REFLECTANTE REFLECTING	
HIDRO HYDRO	
TAPA TOP	
ARO SUJETA BOLSA TASH BAG FIXING RING	
CENICERO ASHTRAY	
APOYABRAZOS ARMREST	●
RESPALDO BACKREST	●
MODULABLE MODULABLE	●
WOODY/SYNTREWOOD	

breinco Colors

SMOOTH



white wet



grey wet



black wet



beige wet

STRIP



white wet



grey wet



black wet



beige wet

geometría geometry

ESCALA 0 CM 50 CM

240 x 46 x 60 cm | 340 x 46 x 60 cm



Frontal | Front view
 Peso | Weight: 2145 kg

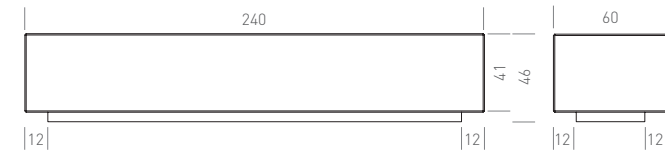

Frontal | Front view
 Lateral | Side view
 Peso | Weight: 1200 kg

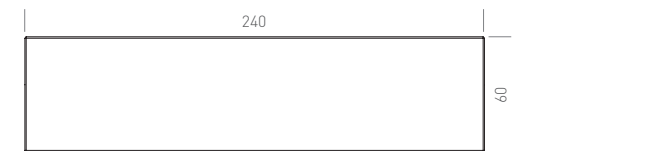

Planta | Plan view

60 x 46 x 60 cm

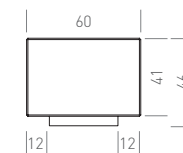

Frontal | Front view
 Peso | Weight: 390 kg

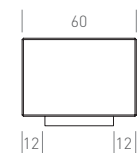

Lateral | Side view

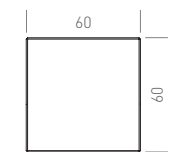

Planta | Plan view

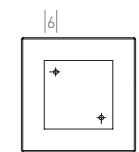

Planta inferior | Bottom view

120 x 46 x 120 cm

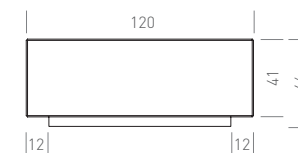

Frontal | Front view
 Peso | Weight: 1570 kg

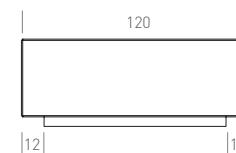

Lateral | Side view

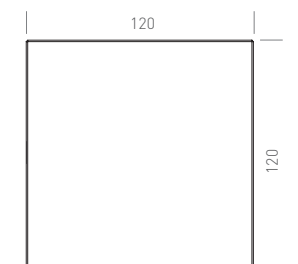

Planta | Plan view

instalación installation

240 x 46 x 60 cm
 340 x 46 x 60 cm

Eslingas de poliéster.
 Polyester slings.

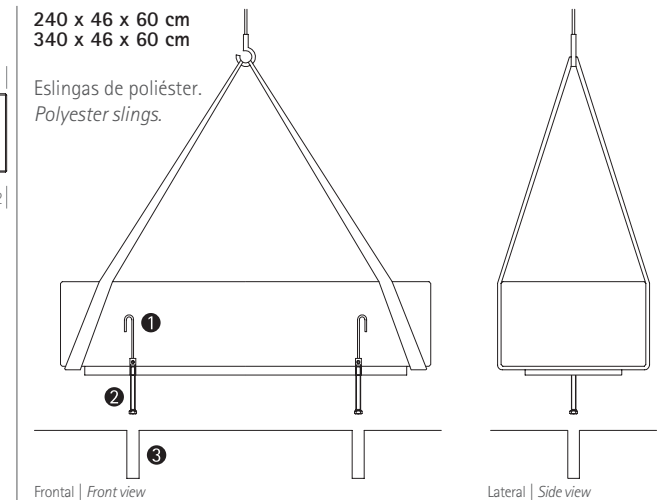

Frontal | Front view

Lateral | Side view

60 x 46 x 60 cm

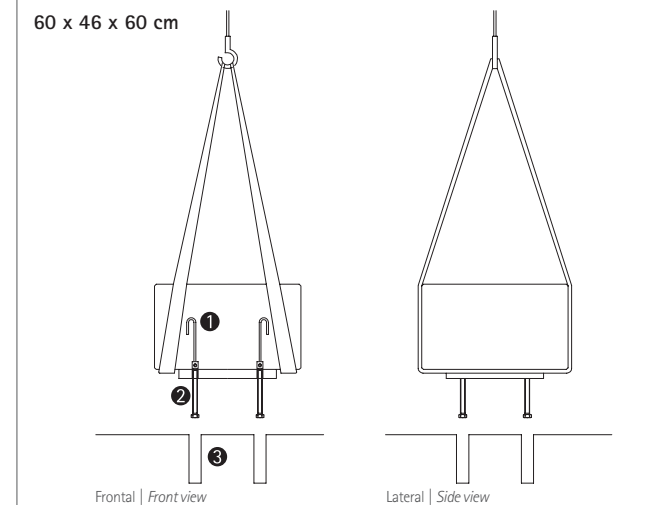

Frontal | Front view

Lateral | Side view

120 x 46 x 120 cm

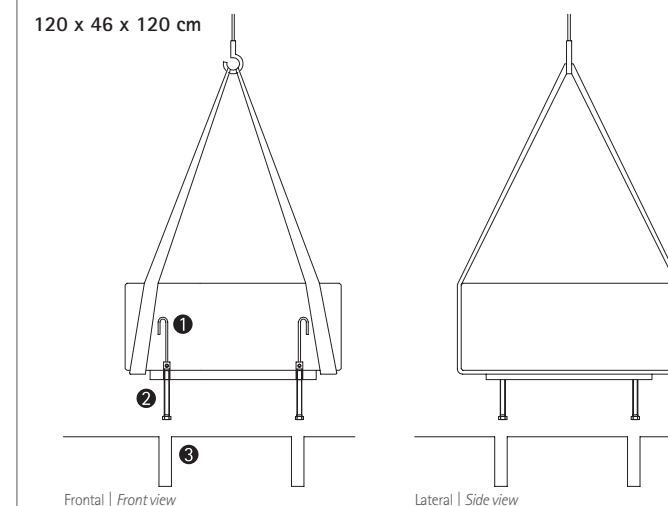

Frontal | Front view

Lateral | Side view

1. Casquillos roscados M16 embebidos.
 2. Tornillos M16 x 140.
 3. Taladrar el pavimento (ø 50 x 180) y llenar con resina o mortero rico.

1. Socket M16
 2. Screws M16 x 140.
 3. Drill pavement (ø 50 x 180) and fill with resin or fat mortar.

timber



El diseño del banco, de la banqueta y de la silla TIMBER traslada las apariencias domésticas y próximas de un asiento de interior al espacio público. Una línea singular de hierro y madera, cómoda, fuerte y fiable.

The design of the benches and the chair TIMBER moves an indoor seat appearance towards the public urban space. A unique style combination of steel and wood, comfortable, robust and reliable.

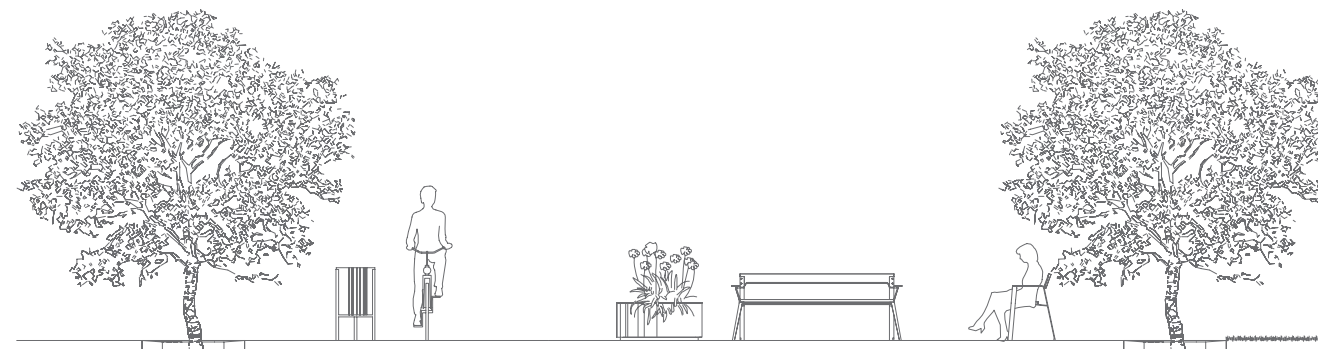

características characteristics



medidas | sizes:

Banco | bench: 200 x 78 x 56 cm

Silla | chair: 80 x 78 x 56 cm

Banqueta sin respaldo | backless bench: 200 x 64 x 48 cm

peso | weight:

Banco | bench: 37 kg

Silla | chair: 23 kg

Banqueta sin respaldo | backless bench: 35 kg

estructura | structure:

Acero cincado mecanizado con protección antioxidante y acabado con pintura en polvo al horno | Zinc plated machined steel with antioxidant protection and stoved powder coating finishing

listones | slats:

Listones de madera europea termotratada | European thermo-treated wooden slats

Listones de madera tropical | Tropical wooden slats

color soporte | support colour:

Black oxiron, grey oxiron, cor-ten oxiron

colocación | fixing:

Base fija. Anclado con tornillos | Fixed base. Anchored with screws

combinaciones combinations



cor-ten oxiron, madera europea / black cor-ten, european wood

opciones options

SEPARADORES METÁLICOS DECORATIVE METAL SPACER	
RUEDAS WHEELS	
LED	
REFLECTANTE REFLECTING	
HIDRO HYDRO	
TAPA TOP	
ARO SUJETA BOLSA TASH BAG FIXING RING	
CENICERO ASHTRAY	
APOYABRAZOS ARMREST	●
RESPALDO BACKREST	●
MODULABLE MODULABLE	
WOODY/SYNTREWOOD	

breinco Colors

estructura | structure:



black oxiron



grey oxiron



cor-ten oxiron

listones | slats:



europea / european



tropical

Certificado FSC madera tropical
FSC Certified tropical wood

geometría geometry

ESCALA 0 CM 50 CM

200 x 78 x 56 cm

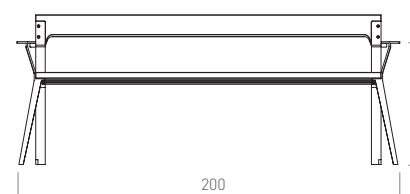

Frontal | Front view
Peso | Weight: 37 kg

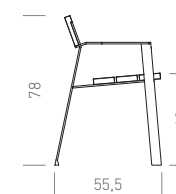

Lateral | Side view

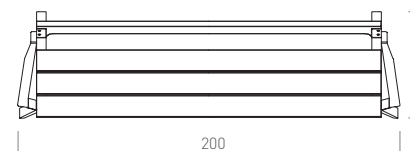

Planta | Plan view

80 x 78 x 56 cm

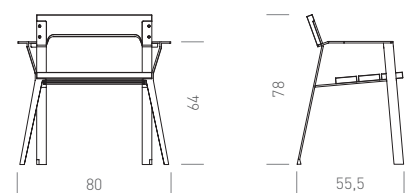

Frontal | Front view
Peso | Weight: 23 kg

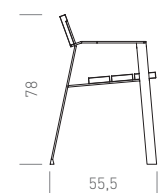

Lateral | Side view

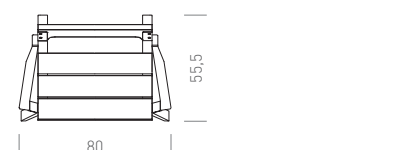

Planta | Plan view

200 x 64 x 48 cm



Frontal | Front view
Peso | Weight: 35 kg

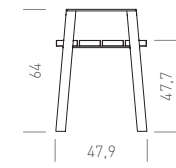

Lateral | Side view

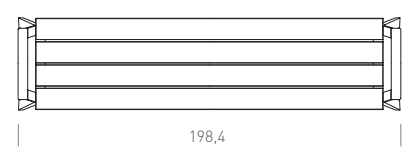

Planta | Plan view

instalación installation

200 x 78 x 56 cm

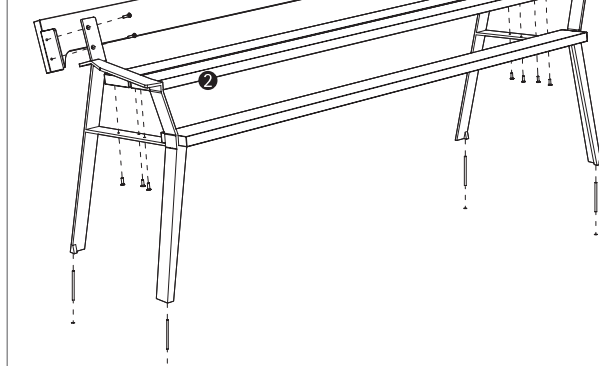

80 x 78 x 56 cm

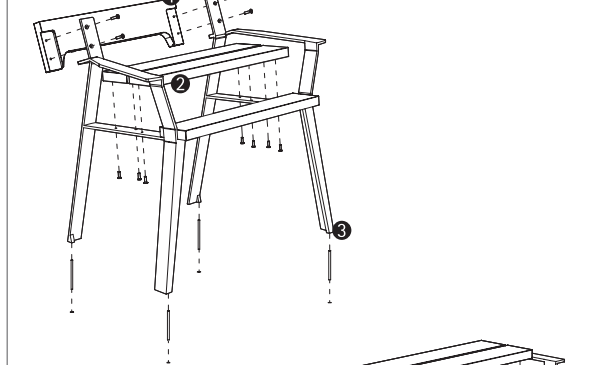

200 x 64 x 48 cm

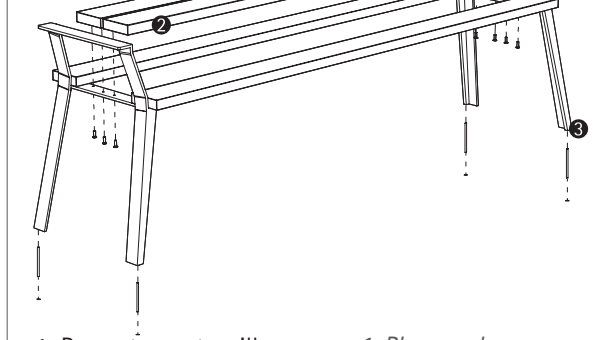

1. Presentar y atornillar el respaldo de madera a la estructura de acero.
2. Atornillar los tres listones del asiento.
3. Se fija el elemento al pavimento mediante cuatro varillas roscadas M8, que se introducen en los orificios previamente realizados en el pavimento y rellenados con resina epoxi, cemento rápido o similar.

1. Place and screw the wooden backrest to the steel support.
2. Screw the three seat slats.
3. The bench is attached to the ground by four screws M8, which are placed in holes that are drilled into the road surface and filled with epoxy resin, quick-setting cement or similar.

terra-screen®

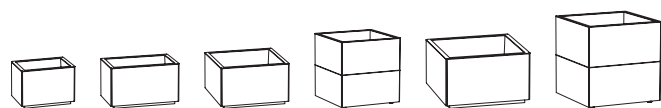

La jardinera Terra-screen® nace como un recipiente de grandes dimensiones para garantizar el funcionamiento radicular de las plantas. Incorpora sistemas de hidroponía para economizar el mantenimiento y una mejor supervivencia de las plantas.

The large size of the Terra-screen® planter was especially designed to ensure proper root behaviour in your plants. It contains hydroponics systems that will reduce maintenance costs and improve plant survival.

características characteristics



medidas | sizes:
 61 x 44 x 61 cm 101 x 104 x 101 cm 101 x 54 x 51 cm
 122 x 64 x 122 cm 101 x 54 x 101 cm 122 x 124 x 122 cm

acabado | finish:

standard

color | colour:

Mediterráneo, ceniza, marfil, desierto, arena, cor-ten, metal, fusion, black

color separador metálico | decorative metal spacer colour:

Matte stainless steel, shiny stainless steel, galvanised, black 9005, white 9003, silver 9006, black oxiron

colocación | fixing:

Simplemente apoyado | Free-standing

personalización | customization:

- Grabado | Engraving
- Ruedas | Wheels
- Color personalizado | Custom colour
- LED | LED
- Hidro jardinera opcional | Optional hydro-planter
- *Incluye cubeta interior | *Includes inner receptacle

combinaciones combinations



sin separadores metálicos / without decorative metal spacer

opciones options

SEPARADORES METÁLICOS DECORATIVE METAL SPACER	•
RUEDAS WHEELS	•
LED	•
REFLECTANTE REFLECTING	
HIDRO HYDRO	•
TAPA TOP	
ARO SUJETA BOLSA TASH BAG FIXING RING	
CENICERO ASHTRAY	
APOYABRAZOS ARMREST	
RESPALDO BACKREST	
MODULABLE MODULABLE	
WOODY/SYNTREWOOD	

breinco Colors

standard

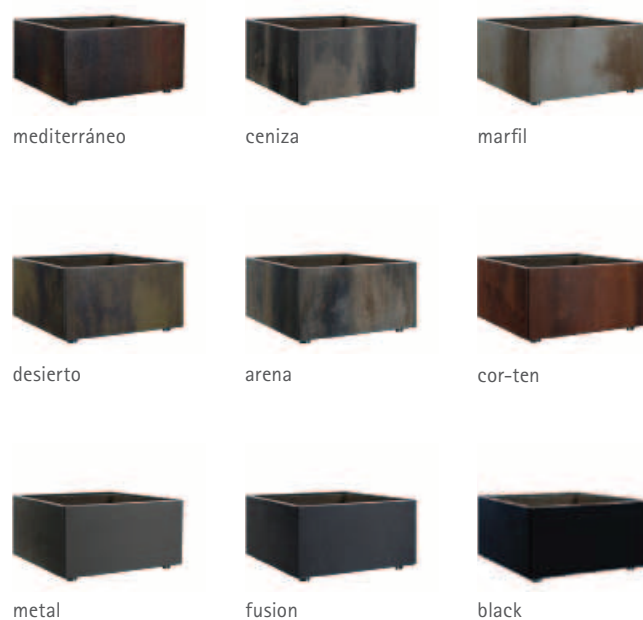

geometría geometry

ESCALA 0 CM 50 CM

61 x 44 x 61 cm



Frontal | Front view

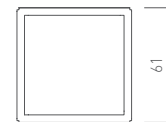

Planta | Plan view
 Peso | Weight: 115 Kg
 Capacidad | Capacity: 110 L

101 x 54 x 51 cm



Frontal | Front view

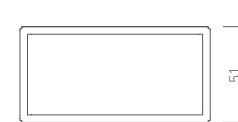

Planta | Plan view
 Peso | Weight: 150 Kg
 Capacidad | Capacity: 200 L

101 x 54 x 101 cm

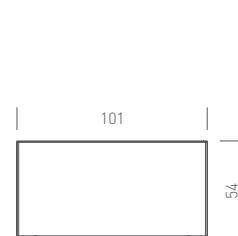

Frontal | Front view

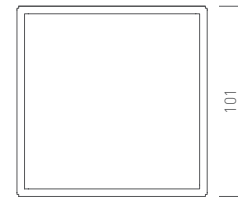

Planta | Plan view
 Peso | Weight: 210 Kg
 Capacidad | Capacity: 430 L

101 x 104 x 101 cm

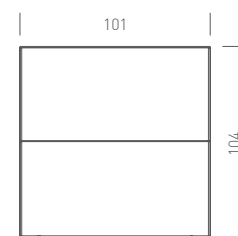

Frontal | Front view

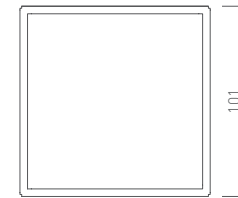

Planta | Plan view
 Peso | Weight: 390 Kg/410 kg
 Capacidad | Capacity: 860 L/730 L

122 x 64 x 122 cm

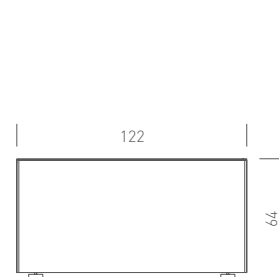

Frontal | Front view

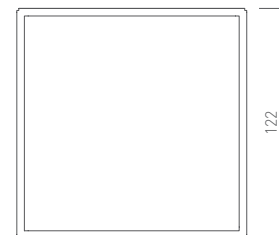

Planta | Plan view
 Peso | Weight: 340 Kg
 Capacidad | Capacity: 760 L

122 x 124 x 122 cm

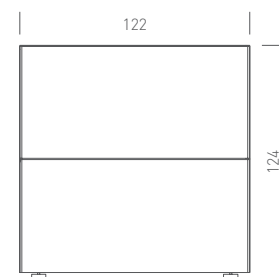

Frontal | Front view

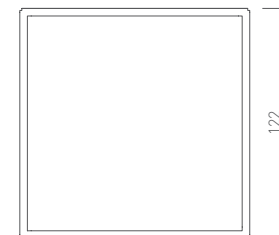

Planta | Plan view
 Peso | Weight: 630 Kg/670 kg
 Capacidad | Capacity: 1520 L/1370 L

instalación installation

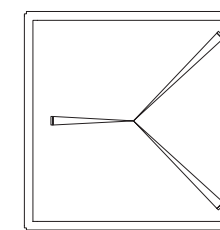
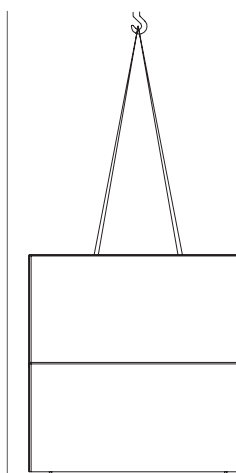

Base regulable
Adjustable base

Eslingas de poliéster
Polyester slings

Árboles recomendados según la capacidad del elemento, página 92-93.
Tree recommended depending on the capacity of element, page 92-93.

Detalle técnico LED | LED technical detail

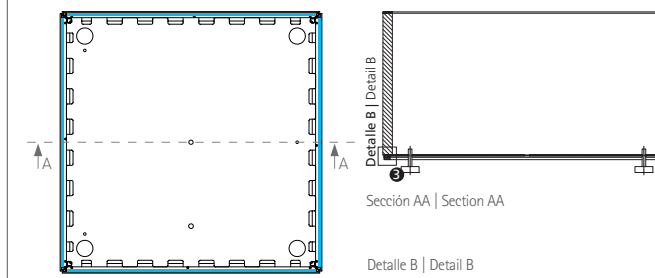

Vista inferior | Bottom view

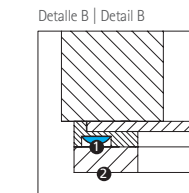

- 1 tira de LED flexible / flexible LED strip
- 2 elemento reflectante / reflective element
- 3 pata niveladora / levelling foot

voltaje | voltage: 12 V

medida LED | LED size: tira de | bande de 10 x 4 mm

consumo por unidad | consumption per unit:

terra-screen® 61 x 44 x 61 cm: 12 W | terra-screen® 101 x 54 x 51 cm: 15 W
 terra-screen® 101 x 54 x 101 cm: 20 W | terra-screen® 101 x 104 x 101 cm: 20 W
 terra-screen® 122 x 64 x 122 cm: 24 W | terra-screen® 122 x 124 x 122 cm: 24 W
 colores | colours: cyan, cold white and warm white
 tipo de LED | LED type: ecoLED TOP CHIP SMD

circle planter



Circle Planter es una jardinera circular y modular, con funciones exigentes de gestión de agua, de sostenibilidad y de interpretación paisajística. Una de sus propiedades es la cualidad de crear espacios e integrar la naturaleza en entornos creados por el hombre.

The Circle Planter is a round, modular planter with functions which control closely water management and make it sustainable and integrate it into the landscape. One of its main features is its capability of creating spaces and integrating nature into man-made surroundings.

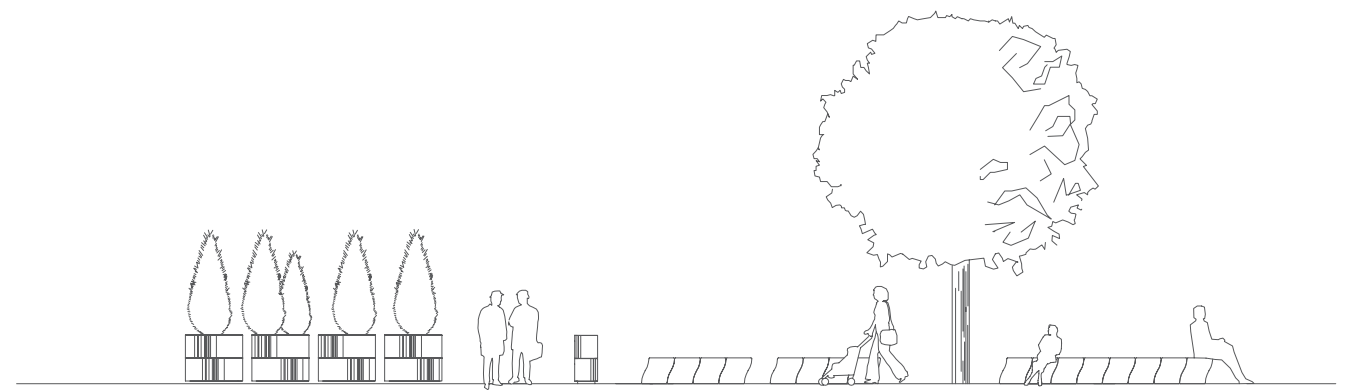

características characteristics



medidas | sizes:
 ø40 x 44 cm ø80 x 49 cm ø100 x 85 cm
 ø45 x 59 cm ø80 x 94 cm ø100 x 125 cm
 ø51 x 44 cm ø100 x 44 cm

acabado | finish:
standard
 color | colour:
 Mediterráneo, ceniza, marfil, desierto, arena, cor-ten, metal, fusion, black

color separador metálico | decorative metal spacer colour:
 Matte stainless steel, shiny stainless steel, galvanised, black 9005, white 9003, silver 9006, black oxiron

colocación | fixing:
 Simplemente apoyado | Free-standing

personalización | customization:
 • Grabado | Engraving
 • Ruedas | Wheels
 • Color personalizado | Custom colour
 • LED | LED

combinaciones combinations



sin separadores metálicos / without decorative metal spacer

opciones options

SEPARADORES METÁLICOS DECORATIVE METAL SPACER	•
RUEDAS WHEELS	•
LED	•
REFLECTANTE REFLECTING	
HIDRO HYDRO	•
TAPA TOP	
ARO SUJETA BOLSA TASH BAG FIXING RING	
CENICERO ASHTRAY	
APOYABRAZOS ARMREST	
RESPALDO BACKREST	
MODULABLE MODULABLE	
WOODY/SYNTREWOOD	

breinco Colors

standard



geometría geometry

ESCALA 0 CM 50 CM

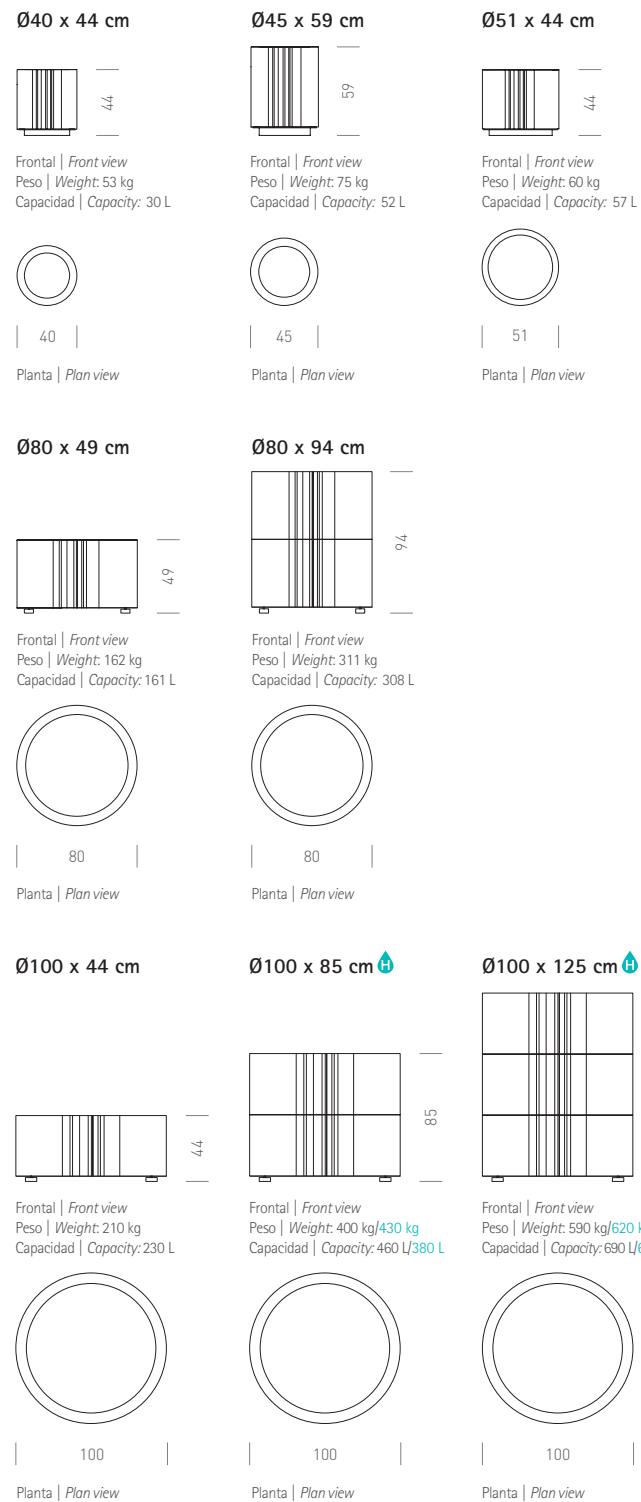

instalación installation

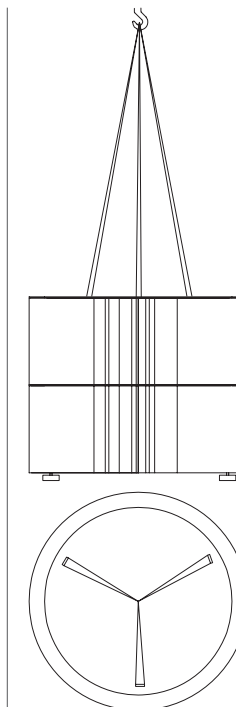

Base regulable
Adjustable base

Elingas de poliéster
Polyester slings

Árboles recomendados según la capacidad del elemento, página 92-93.
Tree recommended depending on the capacity of element, page 92-93.

Detalle técnico Hidro | Hydro technical detail

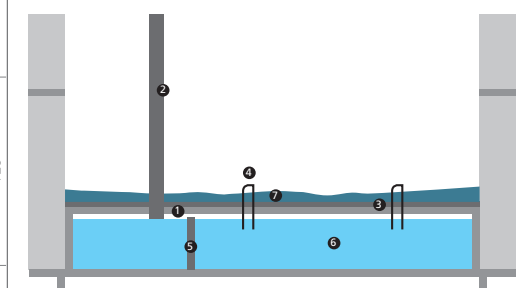

- 1 Chapa perforada 3mm
- 2 Tubo de ventilación
- 3 Geotextil
- 4 Mecha conductora de agua
- 5 Tubo de desagüe
- 6 Depósito de agua
- 7 Capa de drenaje
- 1 3mm perforated plate
- 2 Ventilation pipe
- 3 Geotextile sheet
- 4 Water-conducting wick
- 5 Drainage pipe
- 6 Water tank
- 7 Drainage layer

H Hidrojardinera opcional | Optional hydro-planter
 *Incluye la cubeta interior | Includes inner receptacle

square planter

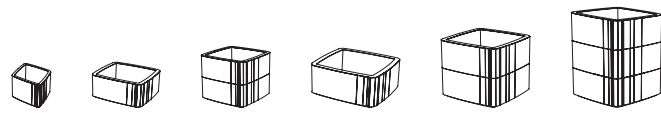

Square Planter es una jardinera modular con tres alturas diferentes. Dependiendo del tipo de plantación, escogeremos el número de módulos que encajamos. Utilizar la medida más grande hidropónica, ayuda a desarrollar los árboles de talla grande.

Square Planter is a modular planter with three different heights. Depending on the type of planting required, choose the number of modules to be joined together. Using the largest hydroponic planter will help larger trees develop more fully.

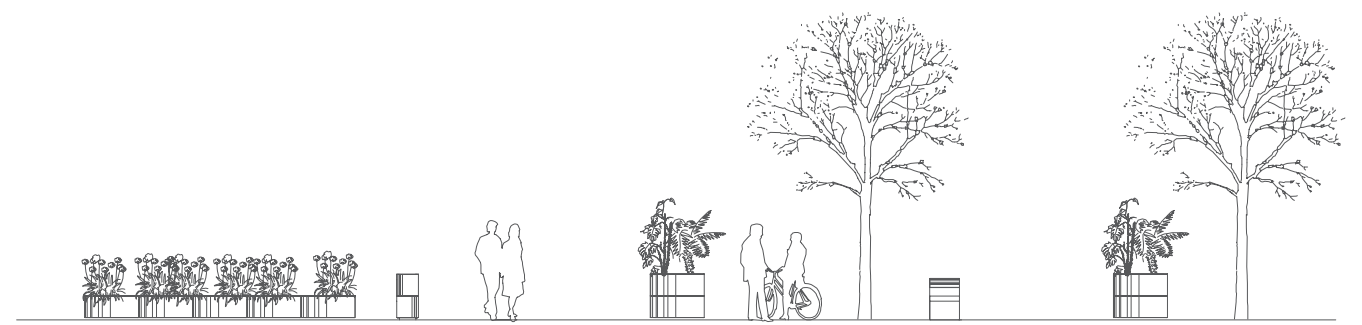

características characteristics



medidas | sizes:
51 x 44 x 51 cm 80 x 94 x 80 cm 100 x 85 x 100 cm
80 x 49 x 80 cm 100 x 44 x 100 cm 100 x 125 x 100 cm

acabado | finish:

standard

color | colour:

Mediterráneo, ceniza, marfil, desierto, arena, cor-ten, metal, fusion, black

color separador metálico | decorative metal spacer colour:

Matte stainless steel, shiny stainless steel, galvanised, black 9005, white 9003, silver 9006, black oxiron

colocación | fixing:

Simplemente apoyado | Free-standing

personalización | customization:

- Grabado | Engraving
- Ruedas | Wheels
- Color personalizado | Custom colour
- LED | LED

• Hidrojardinera opcional | Optional hydro-planter

*Incluye cubeta interior | *Includes inner receptacle

combinaciones combinations



sin separadores metálicos / without decorative metal spacer

opciones options

SEPARADORES METÁLICOS DECORATIVE METAL SPACER	•
RUEDAS WHEELS	•
LED	•
REFLECTANTE REFLECTING	
HIDRO HYDRO	•
TAPA TOP	
ARO SUJETA BOLSA TASH BAG FIXING RING	
CENICERO ASHTRAY	
APOYABRAZOS ARMREST	
RESPALDO BACKREST	
MODULABLE MODULABLE	
WOODY/SYNTREWOOD	

breinco Colors

standard

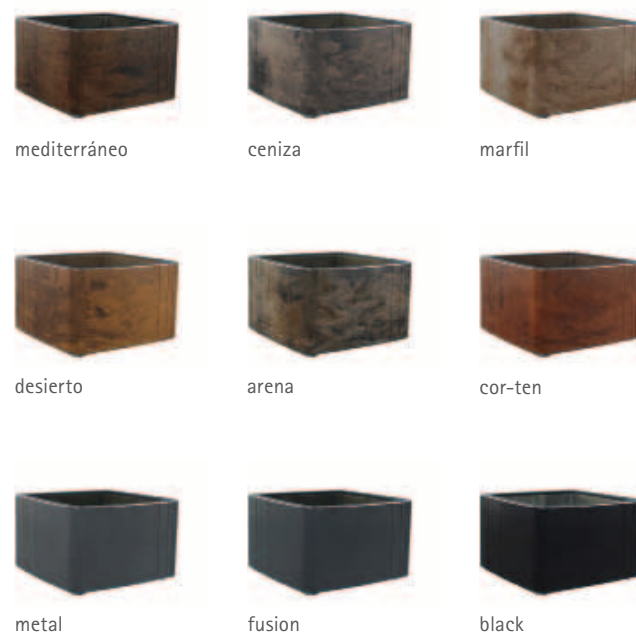

geometría geometry

ESCALA 0 CM 50 CM

51 x 44 x 51 cm

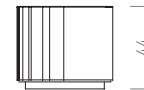

Frontal | Front view
Peso | Weight: 80 kg
Capacidad | Capacity: 72 L

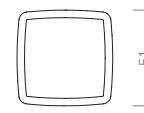

Planta | Plan view

80 x 49 x 80 cm



Frontal | Front view
Peso | Weight: 208 kg
Capacidad | Capacity: 205 L

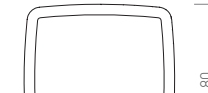

Planta | Plan view

80 x 94 x 80 cm

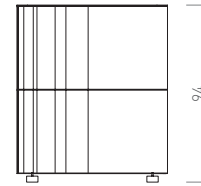

Frontal | Front view
Peso | Weight: 411 kg
Capacidad | Capacity: 393 L

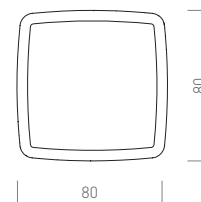

Planta | Plan view

100 x 44 x 100 cm

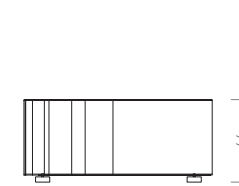

Frontal | Front view
Peso | Weight: 280 kg
Capacidad | Capacity: 290 L

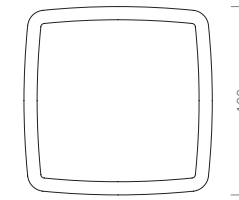

Planta | Plan view

100 x 85 x 100 cm

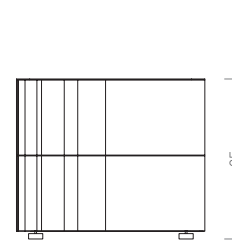

Frontal | Front view
Peso | Weight: 530 kg/560 kg
Capacidad | Capacity: 580 L/480 L

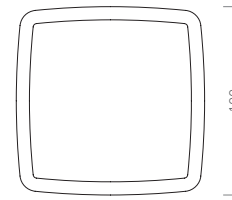

Planta | Plan view

100 x 125 x 100 cm

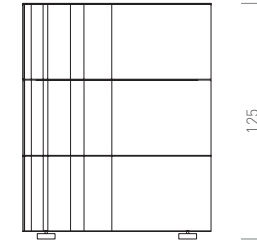

Frontal | Front view
Peso | Weight: 780 kg/810 kg
Capacidad | Capacity: 870 L/770 L

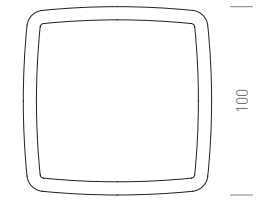

Planta | Plan view

instalación installation

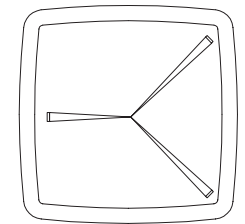
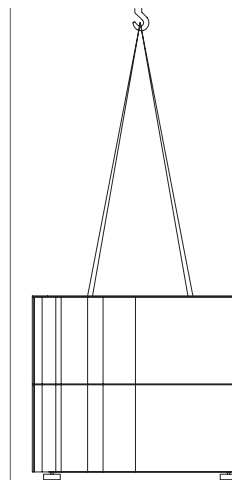

Base regulable
Adjustable base

Eslingas de poliéster
Polyester slings

Árboles recomendados según la capacidad del elemento, página 92-93.
Tree recommended depending on the capacity of element, page 92-93.

Detalle técnico Ruedas | Wheels technical detail

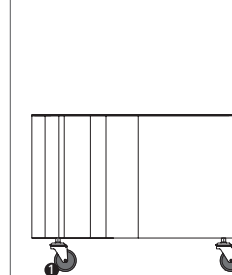

Frontal | Front view

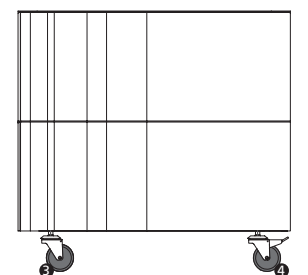

Frontal | Front view

- ① rueda mediana ø 80 mm | medium wheel ø 80 mm
- ② rueda mediana ø 80 mm con freno | medium wheel ø 80 mm with brake
- ③ rueda grande ø 100 mm | large wheel ø 100 mm
- ④ rueda grande ø 100 mm con freno | large wheel ø 100 mm with brake

Tipo de rueda para jardineras Square planter | Wheel for planters 'Square planter'

51 x 44 x 51 cm: rueda pequeña | small wheel

80 x 49 x 80 cm: rueda mediana | medium wheel

80 x 94 x 80 cm: rueda grande | large wheel

100 x 44 x 100 cm: rueda mediana | medium wheel

100 x 85 x 100 cm: rueda grande | large wheel

100 x 125 x 100 cm: rueda grande | large wheel

Características de la ruedas | Wheel characteristics

Rueda pequeña: material plástico negro, diámetro 50mm |

Small wheel: made of black plastic, 50 mm in diameter

Rueda mediana: material nylon, diámetro 80mm |

Medium wheel: made of nylon, 80 mm in diameter

Rueda grande: material nylon, diámetro 100mm |

Large wheel: made of nylon, 100 mm in diameter

rectangular planter

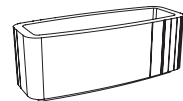

Es una jardinera de forma rectangular, compacta, funcional y de fácil aplicación al entorno. Su recipiente, de pequeñas dimensiones, está diseñado para contener plantas vivaces, arbustivas y de temporada, para así, integrar la naturaleza en el entorno urbano.

A rectangular, compact, functional and easy to install planting box. The pot, with its small size, is designed to contain lively, leafy plants which integrate nature into urban spaces.

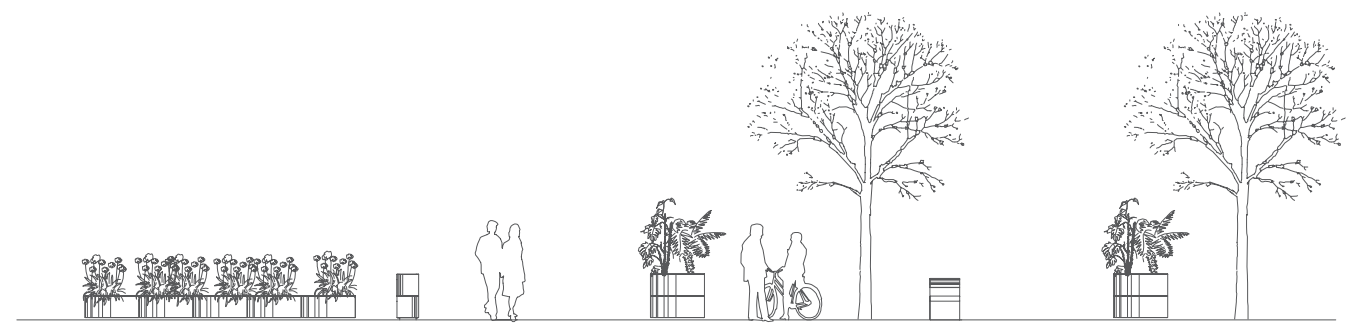

características *characteristics*



medidas | *sizes:*

100 x 44 x 45 cm

acabado | *finish:*

standard

color | *colour:*

Mediterráneo, ceniza, marfil, desierto, arena, cor-ten, metal, fusion, black

color separador metálico | *decorative metal spacer colour:*

Matte stainless steel, shiny stainless steel, galvanised, black 9005, white 9003, silver 9006, black oxiron

colocación | *fixing:*

Simplemente apoyado | *Free-standing*

personalización | *customization:*

- Grabado | *Engraving*
- Color personalizado | *Custom colour*

geometría *geometry*

ESCALA 0 CM 50 CM

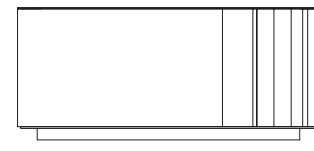

Frontal | *Front view*
Peso | *Weight:* 160 kg
Capacidad | *Capacity:* 110 L

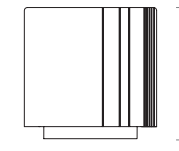

Lateral | *Side view*

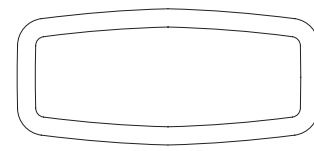

Planta | *Plan view*

instalación *installation*

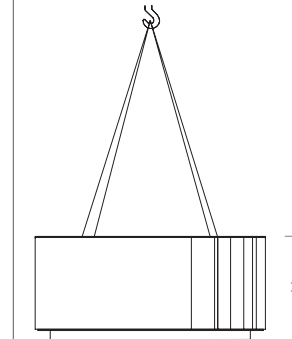

Eslingas de poliéster
Polyester slings

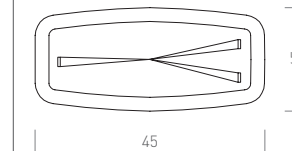

Árboles recomendados según la capacidad del elemento, página 92-93.
Tree recommended depending on the capacity of element, page 92-93.

combinaciones *combinations*



sin separadores metálicos /
without decorative metal spacer

opciones *options*

SEPARADORES METÁLICOS <i>DECORATIVE METAL SPACER</i>	<input type="checkbox"/>
RUEDAS <i>WHEELS</i>	<input type="checkbox"/>
LED	<input type="checkbox"/>
REFLECTANTE <i>REFLECTING</i>	<input type="checkbox"/>
HIDRO <i>HYDRO</i>	<input type="checkbox"/>
TAPA <i>TOP</i>	<input type="checkbox"/>
ARO SUJETA BOLSA <i>TASH BAG FIXING RING</i>	<input type="checkbox"/>
CENICERO <i>ASHTRAY</i>	<input type="checkbox"/>
APOYABRAZOS <i>ARMREST</i>	<input type="checkbox"/>
RESPALDO <i>BACKREST</i>	<input type="checkbox"/>
MODULABLE <i>MODULABLE</i>	<input type="checkbox"/>
WOODY/SYNTREWOOD	<input type="checkbox"/>

breinco *Colors*

standard



mediterráneo



ceniza



marfil



desierto



arena



cor-ten



metal



fusion



black

click



Click es una papeleras con carácter sostenible y ecológico. Es una papeleras de boca abierta de 30 litros de capacidad, de simplicidad proyectual y de gran economía de medios, para lograr la máxima sostenibilidad del producto.

Click is a sustainable, ecological wastepaper basket. It is an open wastepaper basket with 30 litres of capacity which has been designed with simplicity and economy in mind, in order to make the product the most sustainable it can be.



características *characteristics*



medidas | *sizes:*

ø40 x 85 cm

peso | *weight:*

105 Kg

capacidad | *capacity:*

30 l

acabado | *finish:*

standard

color | *colour:*

Mediterráneo, ceniza, marfil, desierto, arena, cor-ten, metal, fusion, black

color separador metálico | *decorative metal spacer colour:*

Matte stainless steel, shiny stainless steel, galvanised, black 9005, white 9003, silver 9006, black oxiron, green 6017, blue 5017, yellow 1018

colocación | *fixing:*

Anclado con tornillos | *Anchored with screws*

personalización | *customization:*

- Grabado | *Engraving*
- Color personalizado | *Custom colour*

combinaciones *combinations*



sin separadores metálicos / *without decorative metal spacer*

opciones *options*

SEPARADORES METÁLICOS DECORATIVE METAL SPACER	•
RUEDAS WHEELS	
LED	
REFLECTANTE REFLECTING	
HIDRO HYDRO	
TAPA TOP	
ARO SUJETA BOLSA TASH BAG FIXING RING	
CENICERO ASHTRAY	
APOYABRAZOS ARMREST	
RESPALDO BACKREST	
MODULABLE MODULABLE	
WOODY/SYNTREWOOD	

breinco *Colors*

standard



mediterráneo



ceniza



marfil



desierto



arena



cor-ten



metal



fusion



black

geometría *geometry*

ESCALA 0 CM 25 CM



Frontal | *Front view*
Peso | *Weight:* 105 kg
Capacidad | *Capacity:* 30 L

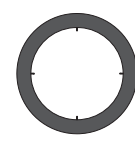

Planta | *Plan view*

Sección | *Section*

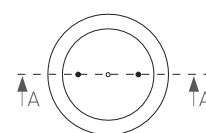

Planta | *Plan view*

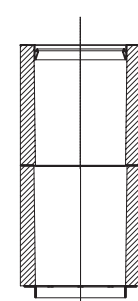

Sección AA | *Section AA*

instalación *installation*

ELEVACIÓN | *HOISTING* (P|W=105 Kg)

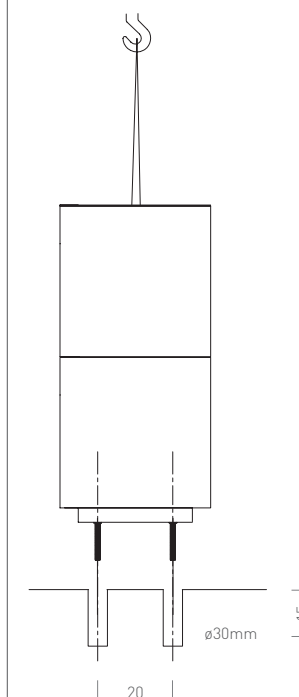

Roscar los tornillos M-12x140.
Taladrar el pavimento (ø30x150)
y llenar con mortero o resina.

Con el elemento se entregan la plantilla
y los pernos de anclaje. Disponibles herramientas
de manipulación.

Tighten the M-12x140 screws. Drill
holes in the paving (ø30x150) and fill
with mortar or resin.

The template and anchoring bolts are supplied
with the element. Tools available for handling.

lift

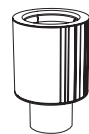

Una papelera diseñada para espacios muy frecuentados y con un espíritu de concienciación ciudadana a favor de la mejora medioambiental de las ciudades. Permite la incorporación de complementos como un cenicero y una tapa superior.

A wastepaper basket designed for crowded spaces and with an spirit of citizen sensibilization towards urban sustainability. Allows the incorporation of complements like an ashtray and a top cover.

características characteristics



medidas | sizes:

ø45 x 78 cm

peso | weight:

80 Kg

capacidad | capacity:

50 l

acabado | finish:

standard

color | colour:

Mediterráneo, ceniza, marfil, desierto, arena, cor-ten, metal, fusion, black

color separador metálico | decorative metal spacer colour:

Matte stainless steel, shiny stainless steel, galvanised, black 9005, white 9003, silver 9006, black oxiron, green 6017, blue 5017, yellow 1018

colocación | fixing:

Anclado con tornillos | Anchored with screws

personalización | customization:

- Grabado | Engraving
- Color personalizado | Custom colour

combinaciones combinations



cenicero / ashtray

opciones options

SEPARADORES METÁLICOS DECORATIVE METAL SPACER	•
RUEDAS WHEELS	
LED	
REFLECTANTE REFLECTING	
HIDRO HYDRO	
TAPA TOP	•
ARO SUJETA BOLSA TASH BAG FIXING RING	
CENICERO ASHTRAY	•
APOYABRAZOS ARMREST	
RESPALDO BACKREST	
MODULABLE MODULABLE	
WOODY/SYNTREWOOD	

breinco Colors

standard



mediterráneo



ceniza



marfil



desierto



arena



cor-ten



metal



fusion



black

geometría geometry

ESCALA 0 CM 25 CM

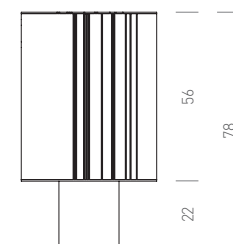

Frontal | Front view
Peso | Weight: 80 kg
Capacidad | Capacity: 50 L

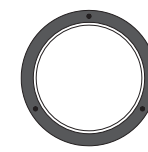

Planta | Plan view

con tapa y cenicero | with top and ashtray

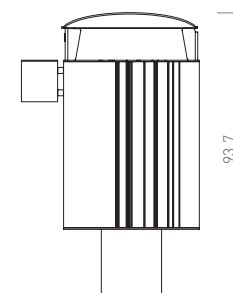

Frontal | Front view

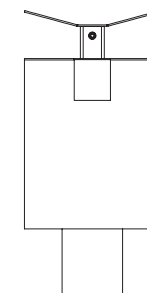

Lateral | Side view

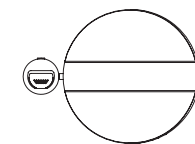

Planta | Plan view

instalación installation

ELEVACIÓN | HOISTING (P|W=80 Kg.)

[1]

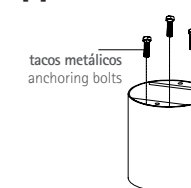

tacos metálicos
anchoring bolts

[2]



tornillos M-10
screws M-10

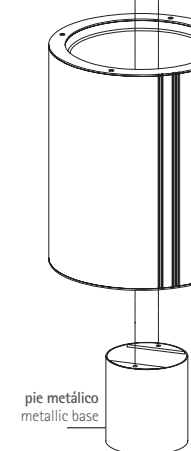

pie metálico
metallic base

[1] Fijar el pie metálico al pavimento con los tacos metálicos.

[2] Colocar la pieza de hormigón sobre el pie. Unir las dos piezas con los tornillos M-10.

Con el elemento se entregan los tacos metálicos y los tornillos M-10.

[1] Fixing in the paving: the metallic base is anchored with anchoring bolts.

[2] Fixing the concrete cylinder with the screws M-10.

The template, anchoring bolts and screws are supplied with the element.

leg

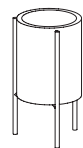

Cilindro de hormigón negro, en simbiosis con la bolsa que contendrá. Es un material que admite una limpieza enérgica sin miedo a estropear su acabado inexistente. La estructura metálica ligera y colorista aporta la opción de fijación de la bolsa por fuera el cilindro sin complejos.

Black concrete cylinder, in symbiosis with the bag that will contain. It is a material that supports a vigorous cleaning without fear of damaging the finishing. The light metal amb colorist structure provides the option of fixing the bag on the outside without complex.

características characteristics



medidas | sizes:

Ø 45 x 85 cm

peso | weight:

63 Kg

capacidad | capacity:

63 l

acabado | finish:

standard

color | colour:

Black

color soporte | support colour:

Black 9005, white 9003, silver 9006, yellow 1018

colocación | fixing:

Anclado con tornillos | Anchored with screws

personalización | customization:

•Aro sujeta bolsa | Tash bag fixing ring

combinaciones combinations



soporte yellow 1018 / yellow 1018 support

opciones options

SEPARADORES METÁLICOS DECORATIVE METAL SPACER	
RUEDAS WHEELS	
LED	
REFLECTANTE REFLECTING	
HIDRO HYDRO	
TAPA TOP	
ARO SUJETA BOLSA TASH BAG FIXING RING	●
CENICERO ASHTRAY	
APOYABRAZOS ARMREST	
RESPALDO BACKREST	
MODULABLE MODULABLE	
WOODY/SYNTREWOOD	

breinco Colors

standard



black



geometría geometry

ESCALA 0 CM 25 CM

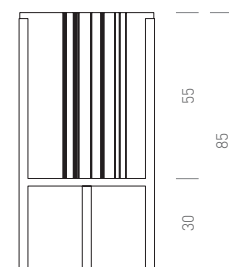

Frontal | Front view
Peso | Weight: 63 kg

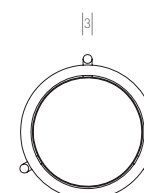

Planta | Plan view

Sección | Section

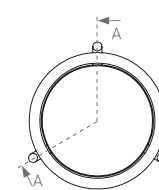

Planta | Plan view

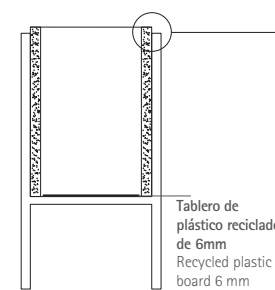

Sección AA | Section AA

Tablero de plástico reciclado de 6mm
Recycled plastic board 6 mm

instalación installation

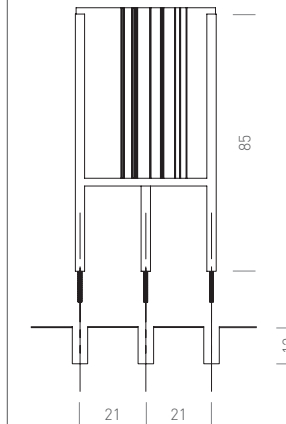

Roscar los tornillos M-10x100. Taladrar el pavimento (Ø14x120) y llenar con mortero o resina.

Con el elemento se entregan la plantilla y los pernos de anclaje.

Tighten the M-10x100 screws. Drill holes in the paving (Ø14x120) and fill with mortar or resin.

The template and anchoring bolts are supplied with the element.

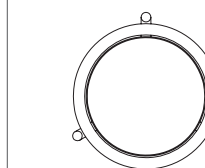

Información técnica de la bolsa | Bag technical detail

Opción 1 | Option 1: sistema de fijación de la bolsa | system of subordination of bag

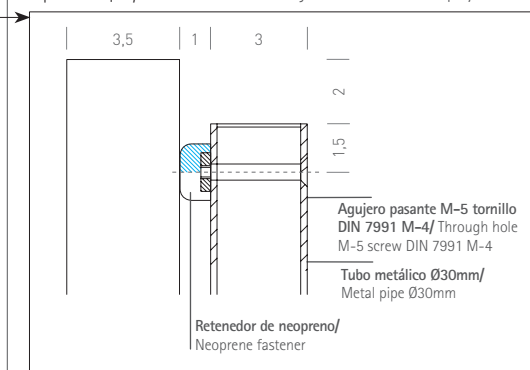

Detalle sección | Detail section

Opción 2 | Option 2: posibilidad de aro sujeta bolsa | optional tash bag fixing ring

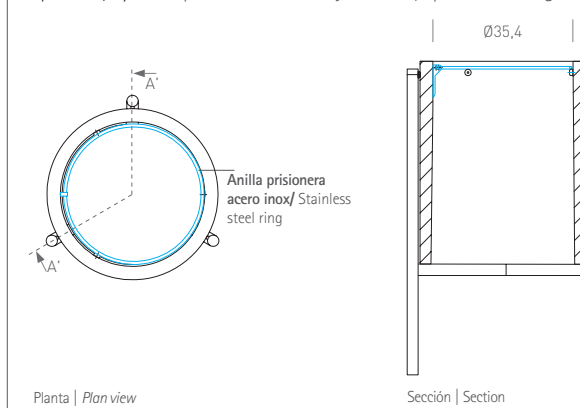

Planta | Plan view

Sección | Section

tree

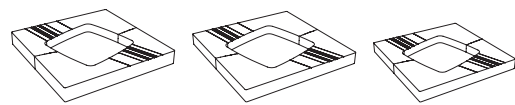

Es la pieza que entiende la función del árbol y otorga protagonismo al elemento arbolado. Con un diseño plenamente integrador y unas dimensiones adecuadas, actúa como recogedor y trabaja como captador de agua y aire, de modo que se convierte en el mejor aliado del árbol.

It is an element which understands the function of the tree and gives it prominence. With a completely integrated design and correct measurements, it acts as a collector and helps to collect air and water, and is therefore the tree's best helper.

características characteristics

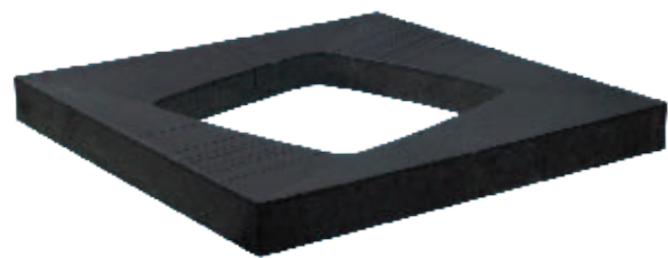

medidas | sizes:
 80 x 10 x 80 cm 100 x 10 x 100 cm 120 x 12 x 120 cm
 peso | weight:
 105 Kg 165 Kg 254 Kg
 acabado | finish:
standard
 color | colour:
 Mediterráneo, ceniza, marfil, desierto, arena, cor-ten, metal, fusion, black
 colocación | fixing:
 Base fija. Colocación con hormigón | Fixed base. Putting in place with concrete

combinaciones combinations



textura Elements / Elements texture

opciones options

SEPARADORES METÁLICOS DECORATIVE METAL SPACER	
RUEDAS WHEELS	
LED	
REFLECTANTE REFLECTING	
HIDRO HYDRO	
TAPA TOP	
ARO SUJETA BOLSA TASH BAG FIXING RING	
CENICERO ASHTRAY	
APOYABRAZOS ARMREST	
RESPALDO BACKREST	
MODULABLE MODULABLE	
WOODY/SYNTREWOOD	

breinco Colors

standard

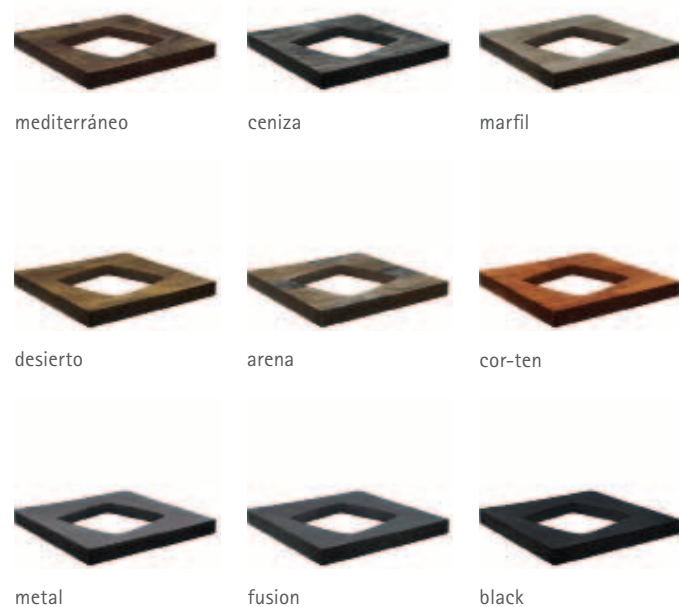

geometría geometry

ESCALA 0 CM 25 CM

80 x 10 x 80 cm



Sección AA | Section AA

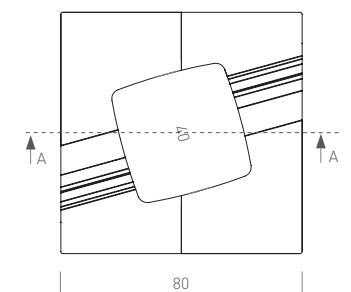

Planta | Plan view
 Peso | Weight: 105 kg

100 x 10 x 100 cm

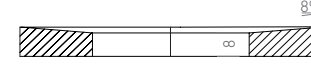

Sección AA | Section AA

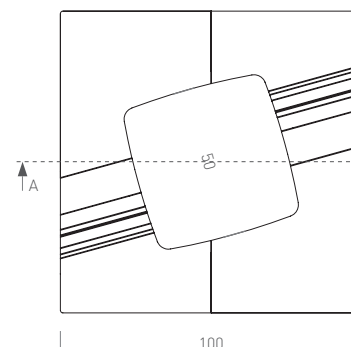

Planta | Plan view
 Peso | Weight: 165 kg

120 x 12 x 120 cm

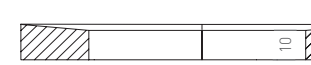

Sección AA | Section AA

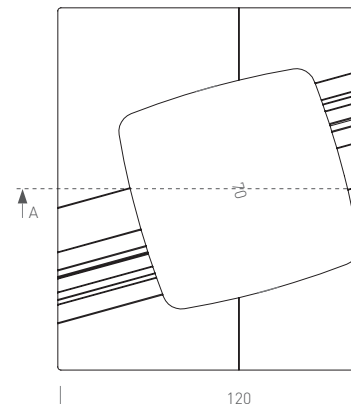

Planta | Plan view
 Peso | Weight: 254 kg

instalación installation

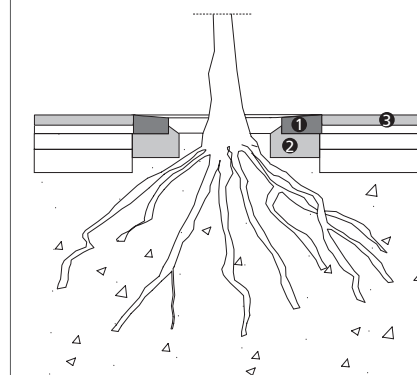

- 1 Tree
- 2 Hormigón
- 3 Pavimento Llosa Vulcano 60 x 40 x 7 cm
- 1 Tree
- 2 Concrete
- 3 Paving Llosa Vulcano 60 x 40 x 7 cm

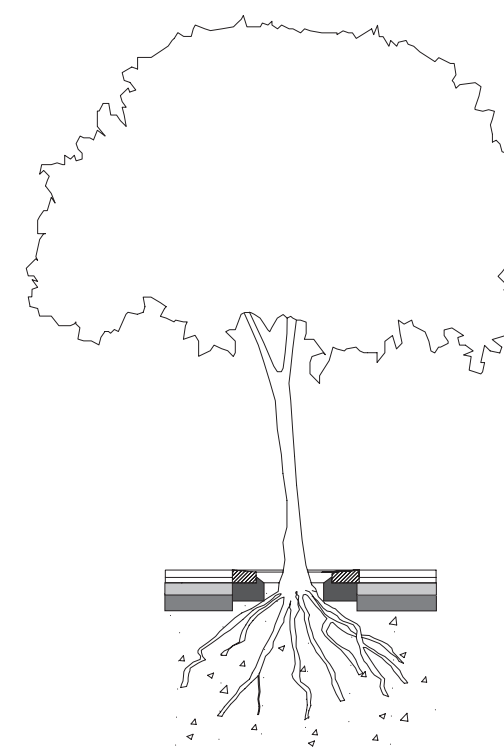

square limit

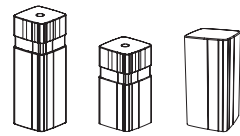

Es un elemento arquitectónico cotidiano diseñado para ejercer la función de delimitar espacios con carácter global. La sencillez del element Square Limit aporta simplicidad de diseño y un valor añadido diferencial en cualquier espacio en que se coloque.

This day-to-day architectural element is designed to limit spaces in general. The simplicity of the Square Limit element adds to its design and means it can be placed anywhere.



características characteristics

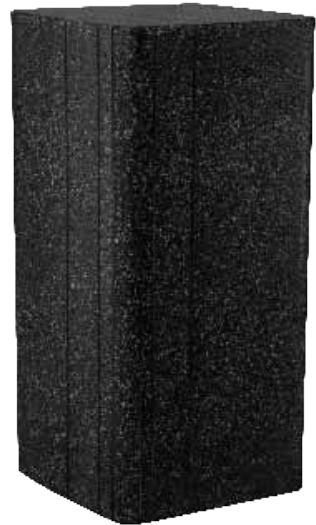

medidas | sizes:
25 x 50 x 25 cm 25 x 50 x 25 cm 25 x 70 x 25 cm

peso | weight:
57 Kg 50 Kg 90 Kg

acabado | finish:

SMOOTH

color | colour:

White, metal, fusion, black, basalt

colocación | fixing:

Anclado con tornillos | *Anchored with screws*

complementos | complements:

• Iluminación LED | *LED lighting*

geometría geometry

ESCALA 0 CM 25 CM

25 x 50 x 25 cm



Frontal | Front view

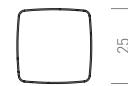

Planta | Plan view

Peso | Weight: 57 kg

con LED | with LED

25 x 50 x 25 cm

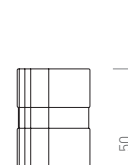

Frontal | Front view



Planta | Plan view

Peso | Weight: 50 kg

25 x 70 x 25 cm

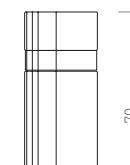

Frontal | Front view



Planta | Plan view

Peso | Weight: 90 kg

instalación installation

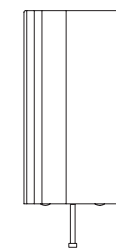

Varilla de roscar M-20x180. Perforar el pavimento (ø30x190) y llénalo de mortero o resina.

Con el elemento se entrega una varilla de roscar M-20 X 180.

M-20x180 threaded rod. Drill holes in the paving (ø30x190) and fill with mortar or resin.

A threaded M-20x180 rod is supplied with the element.



combinaciones combinations



LED | LED

opciones options

SEPARADORES METÁLICOS DECORATIVE METAL SPACER	
RUEDAS WHEELS	
LED LED	•
REFLECTANTE REFLECTING	
HIDRO HYDRO	
TAPA TOP	
ARO SUJETA BOLSA TASH BAG FIXING RING	
CENICERO ASHTRAY	
APOYABRAZOS ARMREST	
RESPALDO BACKREST	
MODULABLE MODULABLE	
WOODY/SYNTREWOOD	

breinco Colors

SMOOTH pulido e hidrofugado | *polished and waterproofed*



white



metal



fusion



black



basalt

Detalle técnico LED | LED technical detail

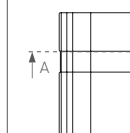

Frontal | Front view



Planta | Plan view

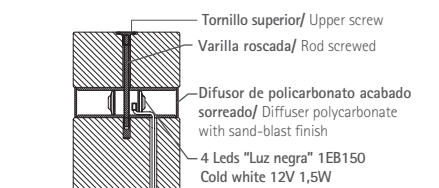

Sección A'A' | Section A'A'



Sección AA | Section AA



Conexión Leds/ LED connection

Cuadrado de aluminio/ Square of aluminium

Sección AA | Section AA

voltaje | voltage: 12 V

medida LED | LED size: 54 x 42 mm

consumo por unidad | consumption per unit: 1,5 W x 4u = 6 W

colores | colours: cold white

tipo de LED | LED type: Eco LED

dune limit

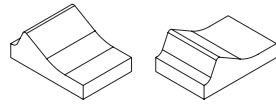

Es el elemento horizontal que se eleva y se inclina para transformar y redirigir un producto. Es un elemento multifuncional que se complementa a partir de un elemento existente. Crea una continuidad de los elementos aplicados con una vinculación evidente entre ellos.

It is the horizontal element which elevates and inclines in order to redirect such an established. It is a multifunctional element which complements an already existing element and creates continuity with a clear link between them.



características characteristics



medidas | sizes:
40 x 24 x 60 cm

peso | weight:
69 Kg

acabado | finish:

standard

color | colour:

Mediterráneo, ceniza, marfil, desierto, arena, cor-ten, metal, fusion, black

colocación | fixing:

Base fija. Colocación con mortero | Fixed base. Placement with mortar

complementos | complements:

• Iluminación LED | LED lighting

geometría geometry

ESCALA 0 CM 25 CM

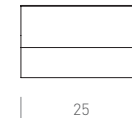

Frontal | Front view

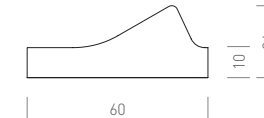

Lateral | Side view



Planta | Plan view
Peso | Weight: 69 kg

instalación installation

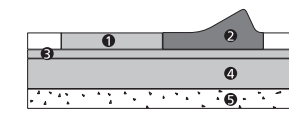
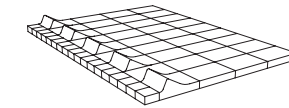

Sección AA | Section AA

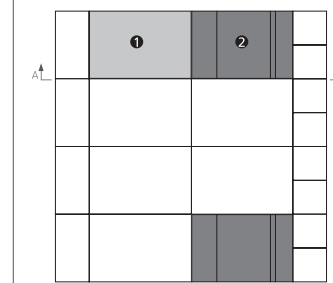

Planta | Plan view

- 1 Llosa Vulcano
- 2 Dune limit
- 3 3 cm mortero
- 4 Losa de hormigón
- 5 Explanada

- 1 Llosa Vulcano
- 2 Dune limit
- 3 3 cm mortar
- 4 Concrete slab
- 5 Embankment

combinaciones combinations



LED | LED

opciones options

SEPARADORES METÁLICOS DECORATIVE METAL SPACER	
RUEDAS WHEELS	
LED LED	●
REFLECTANTE REFLECTING	
HIDRO HYDRO	
TAPA TOP	
ARO SUJETA BOLSA TASH BAG FIXING RING	
CENICERO ASHTRAY	
APOYABRAZOS ARMREST	
RESPALDO BACKREST	
MODULABLE MODULABLE	●
WOODY/SYNTREWOOD	

breinco Colors

standard



mediterráneo



ceniza



marfil



desierto



arena



cor-ten



metal



fusion



black

Detalle técnico LED | LED technical detail

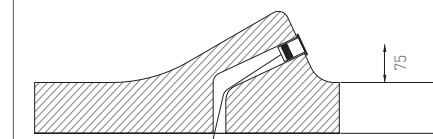

Sección | Section

voltaje | voltage: 6 - 24 V

medida LED | LED size: Ø31, h = 45 mm

consumo por unidad | consumption per unit: 1 W

colores | colours: cyan, cold white and warm white

tipo de LED | LED type: Cree xp-g

prisma limit

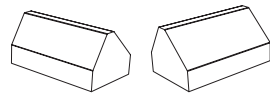

El Prisma Limit nos permite delimitar espacios de diferente naturaleza en cuanto a su uso e incluir instrucciones o proporcionar cierto tipo de información al usuario. Está diseñado en complementariedad de tonalidades para su integración armoniosa con el espacio público.

Prisma Limit allows us to separate off different spaces, include instructions or offers certain types of information to the user. It is designed in a wide range of tones in order to guarantee harmony with any surrounding elements in public spaces.

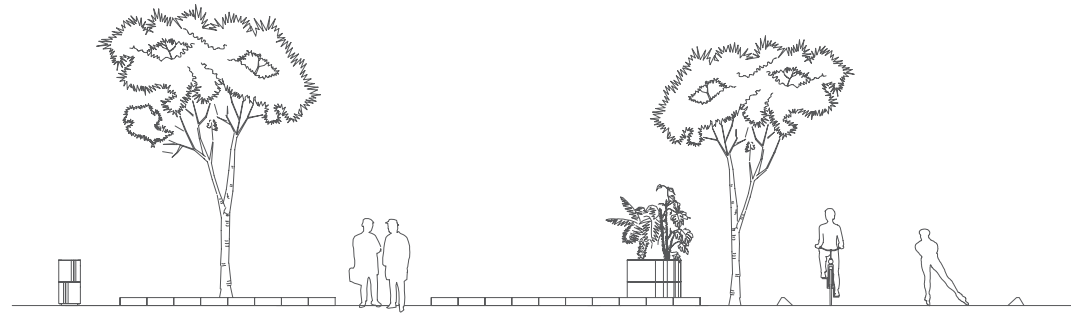

características *characteristics*



medidas | *sizes:*
50 x 25 x 30 cm

peso | *weight:*

61 Kg

acabado | *finish:*

standard

color | *colour:*

Mediterráneo, ceniza, marfil, desierto, arena, cor-ten, metal, fusion, black

colocación | *fixing:*

Base fija. Colocación con mortero | *Fixed base. Placement with mortar*

complementos | *complements:*

• Iluminación LED | *LED lighting*

geometría *geometry*

ESCALA 0 CM 25 CM



Frontal | *Front view*
Peso | *Weight:* 61 kg



Lateral | *Side view*

instalación *installation*

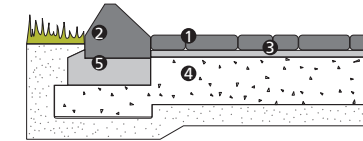

Sección AA | *Section AA*

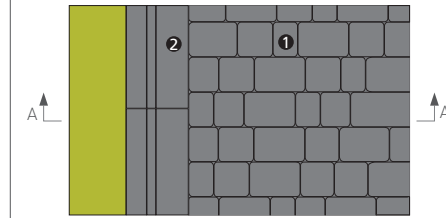

Vista inferior | *Bottom view*

- | | |
|---------------------------------------------------------|---------------------------------------------------------|
| 1 Tegula art
24 x 16 x 6 16 x 16 x 6 12 x 16 x 6 | 1 Tegula art
24 x 16 x 6 16 x 16 x 6 12 x 16 x 6 |
| 2 Prisma limit | 2 Prisma limit |
| 3 3cm de arena 0-5mm | 3 3cm of sand 0-5mm |
| 4 Explanada mejorada | 4 Improved embankment |
| 5 Hormigón | 5 Concrete |

combinaciones *combinations*



LED | *LED*

opciones *options*

SEPARADORES METÁLICOS DECORATIVE METAL SPACER	
RUEDAS WHEELS	
LED LED	●
REFLECTANTE REFLECTING	
HIDRO HYDRO	
TAPA TOP	
ARO SUJETA BOLSA TASH BAG FIXING RING	
CENICERO ASHTRAY	
APOYABRAZOS ARMREST	
RESPALDO BACKREST	
MODULABLE MODULABLE	●
WOODY/SYNTREWOOD	

breinco *Colors*

standard



mediterráneo



ceniza



marfil



desierto



arena



cor-ten



metal



fusion



black

Detalle técnico LED | *LED technical detail*

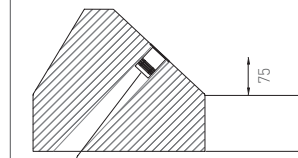

Sección | *Section*

voltaje | *voltage:* 6 - 24 V
medida LED | *LED size:* Ø31, h = 45 mm
consumo por unidad | *consumption per unit:* 1 W
colores | *colours:* cyan, cold white and warm white
tipo de LED | *LED type:* Cree xp-g

fita

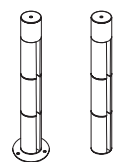

Fita es un elemento urbano protector y disuasivo que incorpora una iluminación vinculada a una señalética y a unos límites físicos. Está diseñado con un alma interna de sujeción y un capuchón que alberga una lámpara con tecnología LED.

Fita is an urban element to protect and dissuade and incorporates lighting linked to a system of signals and physical limits. It is designed with a body for fixing and a top which houses a LED technology bulb.

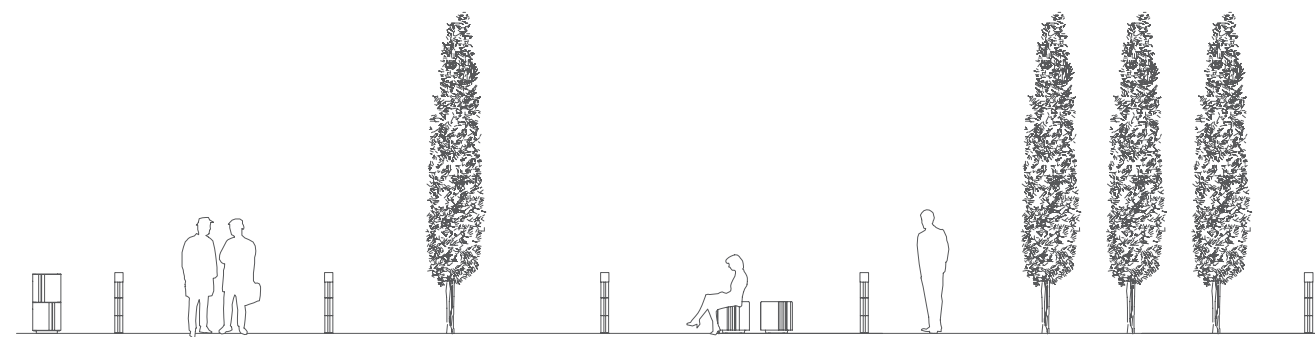

características characteristics



- medidas | sizes: **Ø11,5 x 88 cm**
 peso | weight: **16 Kg**
 acabado | finish: **standard**
 color | colour: **Mediterráneo, ceniza, marfil, desierto, arena, cor-ten, metal, fusion, black**
 color superior | top colour: **Matte stainless steel, shiny stainless steel, galvanised, black 9005, white 9003, silver 9006, black oxiron**
 colocación | fixing: **Empotrado o con tornillos | Embedded or with screws**
 personalización | customization: **Grabado | Engraving**
 complementos | complements: **Iluminación LED | LED lighting**
Cenicero opcional | Optional ashtray

combinaciones combinations

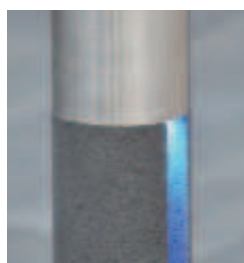

LED / LED



cenicero / ashtray

opciones options

SEPARADORES METÁLICOS DECORATIVE METAL SPACER	
RUEDAS WHEELS	
LED LED	●
REFLECTANTE REFLECTING	
HIDRO HYDRO	
TAPA TOP	
ARO SUJETA BOLSA TASH BAG FIXING RING	
CENICERO ASHTRAY	●
APOYABRAZOS ARMREST	
RESPALDO BACKREST	
MODULABLE MODULABLE	
WOODY/SYNTREWOOD	

breinco Colors



geometría geometry

ESCALA 0 CM 25 CM

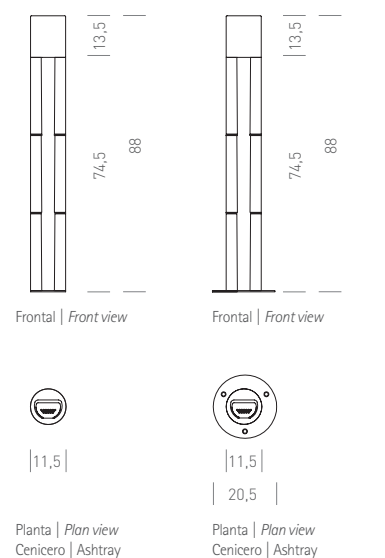
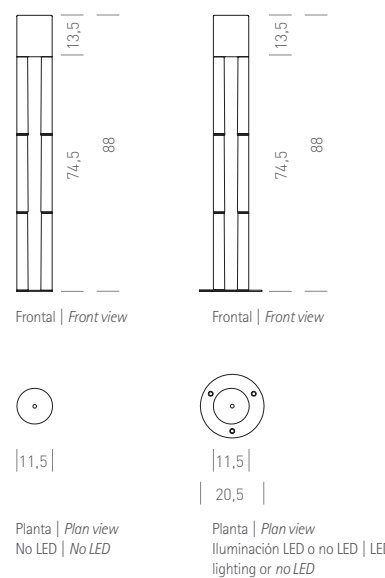

instalación installation

Opción 1 | Option 1: anclaje mecánico visto | anchored with screws
 Opción 2 | Option 2: empotramiento directo | direct embedded

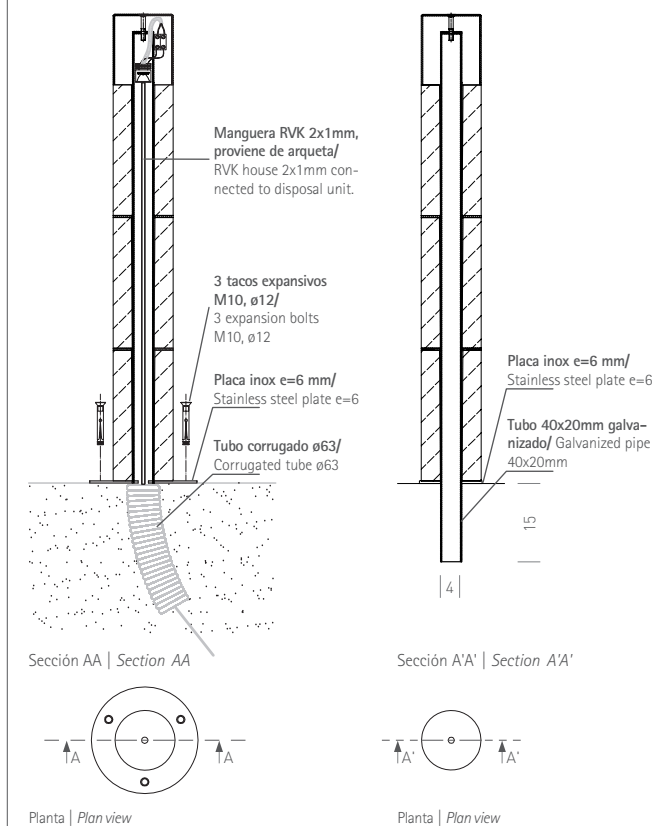

FITA con LED, anclada con tornillos. FITA sin LED o con cenicero, anclaje opcional con tornillos o empotramiento.

FITA with LED lighting anchored with screws. No LED lighting or with ashtray optional anchored with screws or embedded.

Detalle técnico LED | LED technical detail

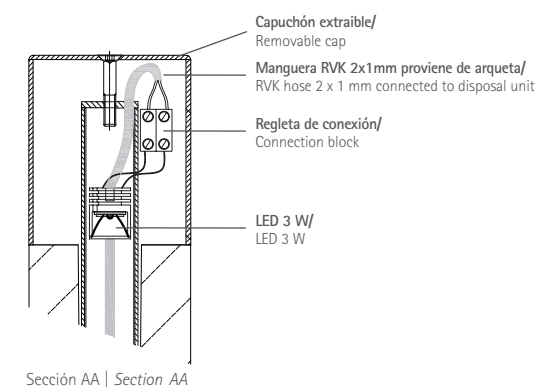

voltaje | voltage: 6 - 24 V
 medida LED | LED size: Ø31, h = 45 mm
 consumo por unidad | consumption per unit: 3 W
 colores | colours: cyan, cold white and warm white
 tipo de LED | LED type: Cree xp-g

angle limit

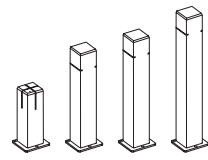

Pilona de sección cuadrada y elemento reflectante superior que delimita espacios para crear sensación de seguridad o como barrera física de conducción de peatones. La familia Angle se caracteriza por su simplicidad y adaptabilidad a cualquier espacio.

Bollard of square section with a reflective element on upper part for limiting spaces and to create a feeling of security or a physical barrier for guiding pedestrians. The Angle family is characterized by its simplicity and adaptability to any space.

características characteristics



medidas | sizes:
 13 x 40 x 13 cm 13 x 70 x 13 cm 13 x 80 x 13 cm
 13 x 96 x 13 cm
 peso | weight:
 16 Kg 28 Kg 32 Kg
 39 Kg
 acabado | finish:
SMOOTH
 color | colour:
 White, metal, fusion, black
 colocación | fixing:
 Anclaje mecánico visto | *Anchored with screws*
 complementos | complements:
 • Reflectante | *Reflecting*:
 green - 13 x 40 x 13 cm
 orange - 13 x 70 x 13 cm
 orange - 13 x 80 x 13 cm
 orange - 13 x 96 x 13 cm

combinaciones combinations

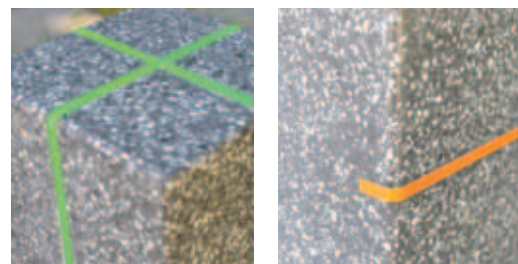

reflectante / reflecting

opciones options

SEPARADORES METÁLICOS DECORATIVE METAL SPACER	
RUEDAS WHEELS	
LED	
REFLECTANTE REFLECTING	●
HIDRO HYDRO	
TAPA TOP	
ARO SUJETA BOLSA TASH BAG FIXING RING	
CENICERO ASHTRAY	
APOYABRAZOS ARMREST	
RESPALDO BACKREST	
MODULABLE MODULABLE	
WOODY/SYNTREWOOD	

breinco Colors

SMOOTH pulido e hidrofugado | polished and waterproofed



black

geometría geometry

ESCALA 0 CM 25 CM

13 x 40 x 13 cm

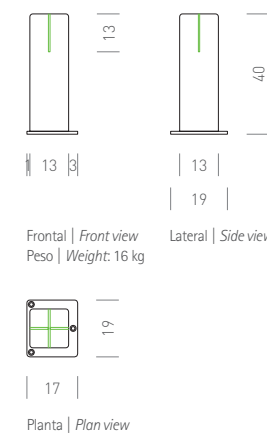

Frontal | Front view
Peso | Weight: 16 kg

Lateral | Side view

Planta | Plan view

13 x 70 x 13 cm

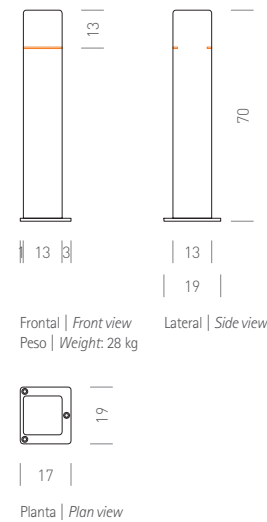

Frontal | Front view
Peso | Weight: 28 kg

Lateral | Side view

Planta | Plan view

13 x 80 x 13 cm

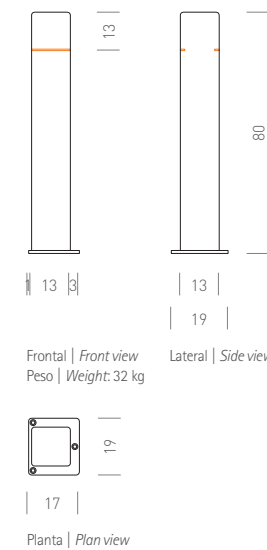

Frontal | Front view
Peso | Weight: 32 kg

Lateral | Side view

Planta | Plan view

13 x 96 x 13 cm

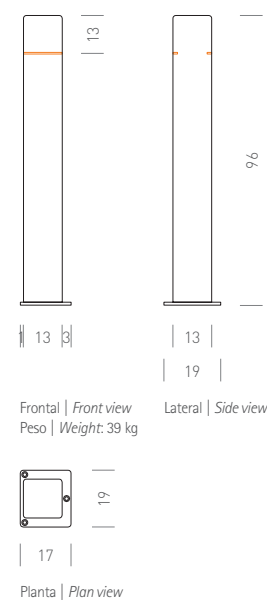

Frontal | Front view
Peso | Weight: 39 kg

Lateral | Side view

Planta | Plan view

instalación installation

Opción 1 | *Option 1: anclaje mecánico visto | anchored with screws*

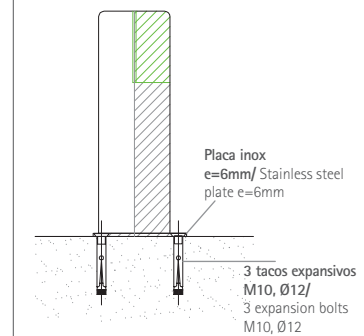

Seleccionar la posición de la pilona y atornillar los tacos expansivos (Ø12x100) al pavimento.

Select the limit position and screw the expansion bolts (Ø12x100) to the paving.

Sección AA | Section AA

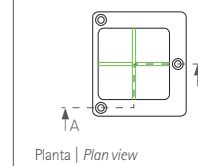

Planta | Plan view

Opción 2 | *Option 2: empotramiento directo | direct embedded*

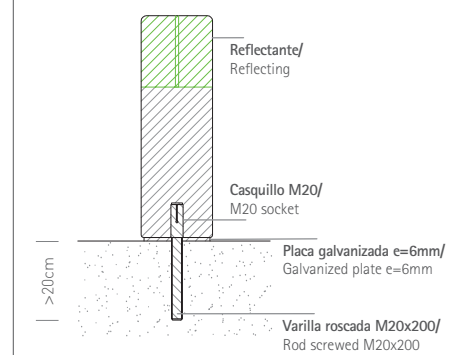

Sección A'A' | Section A'A'

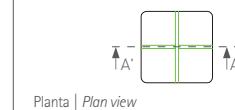

Planta | Plan view

*H=40cm - Para delimitar visualmente y crear sensación de seguridad/
H=40cm - For limiting spaces and to create a feeling of security
 *H=70/80/96cm - Barrera física de conducción de peatones/
H=70/80/96cm - Physical barrier for guiding pedestrians

angle marker

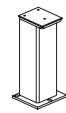

La baliza Angle marker es un elemento señalizador de líneas simples y elegantes. Está equipada con una tira estanca de Led en su placa superior, que de noche, representa el flujo vital de la ciudad y de sus habitantes.

The beacon Angle marker is an indication element with simple and elegant lines. It is equipped with a waterproof Led strip on its upper plate, representing at night the city's life flow and that of its inhabitants.

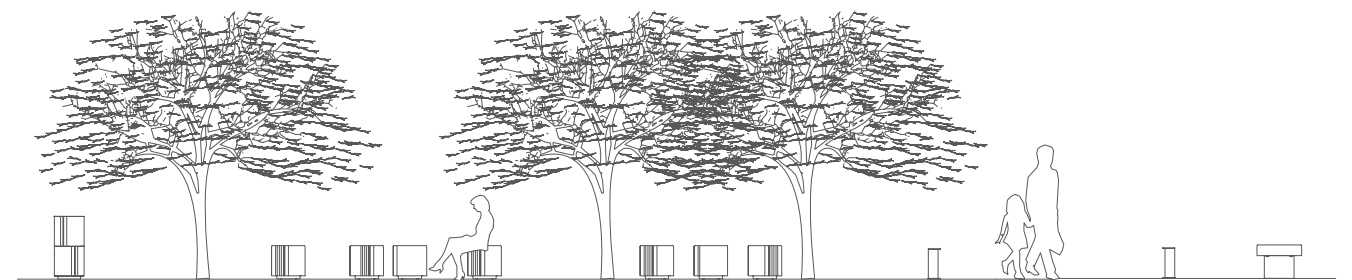

características characteristics



medidas | sizes:
13 x 40 x 13 cm

peso | weight:

17 Kg

acabado | finish:

SMOOTH

color | colour:

White, metal, fusion, black

colocación | fixing:

Anclaje mecánico visto | *Anchored with screws*

personalizable | customization:

• Grabado en placa de aluminio | *Engraving aluminum plate*

complementos | complements:

• Iluminación LED | *LED lighting*

geometría geometry

ESCALA 0 CM 25 CM

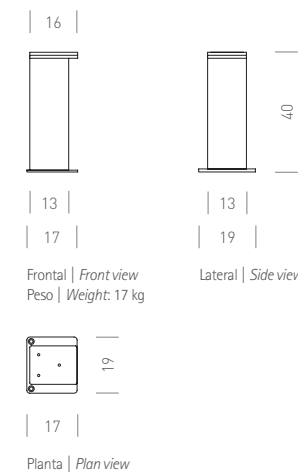

instalación installation

Opción 1 | *Option 1: anclaje mecánico visto | anchored with screws*

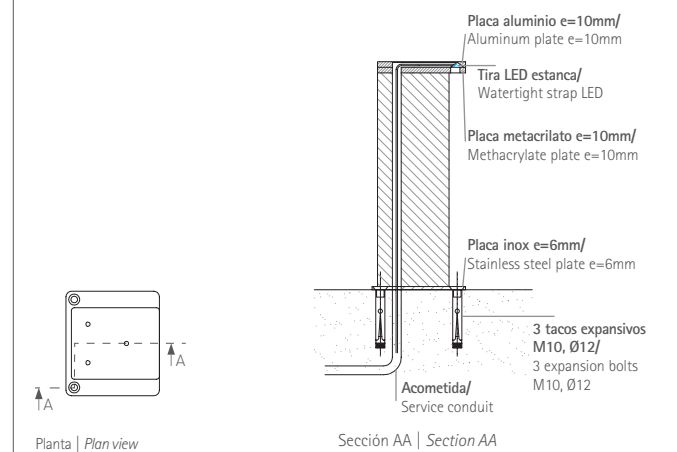

Opción 2 | *Option 2: empotramiento directo | encastrament direct*

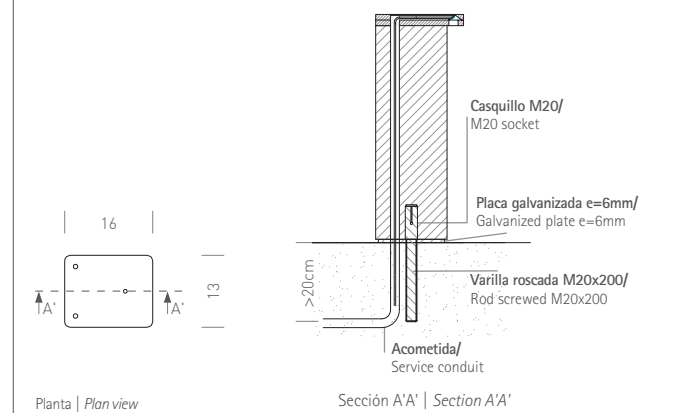

Detalle técnico LED | LED technical detail

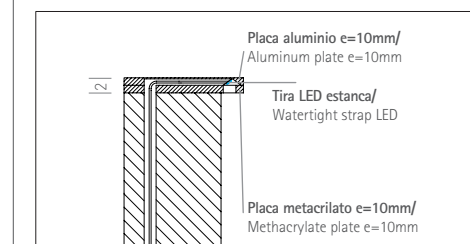

voltaje | voltage: 12 V

medida LED | LED size: tira de | bande de a=10mm x a=4mm x l=110mm

consumo por unidad | consumption per unit: 0,55 W

colores | colours: cyan, cold white and warm white

combinaciones combinations



iluminación LED /
LED lighting

opciones options

SEPARADORES METÁLICOS DECORATIVE METAL SPACER	
RUEDAS WHEELS	
LED LED	●
REFLECTANTE REFLECTING	
HIDRO HYDRO	
TAPA TOP	
ARO SUJETA BOLSA TASH BAG FIXING RING	
CENICERO ASHTRAY	
APOYABRAZOS ARMREST	
RESPALDO BACKREST	
MODULABLE MODULABLE	
WOODY/SYNTREWOOD	

breinco Colors

SMOOTH pulido e hidrofugado | polished and waterproofed



white



metal



fusion



black

angle line

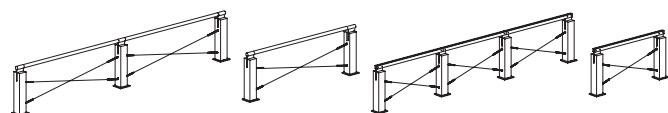

Esta baranda permite numerosas combinaciones, en altura, colores de las piezas, de fijación y diferentes materiales del pasamanos. Un cable de acero cose los soportes para reforzar la separación de zonas transitables a zonas no accesibles.

This handrail allows a number of combinations in height, color of attachments and different materials of the banister. A steel cable stitch the supports in order to reinforce the separation of walking areas from not accessible sites.

características characteristics



medidas | sizes:

130 x 80 x 13 cm | 101 Kg
130 x 90 x 13 cm | 109 Kg



390 x 80 x 13 cm | 239 Kg
390 x 90 x 13 cm | 255 Kg

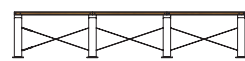

200 x 80 x 13 cm | 119 Kg
200 x 90 x 13 cm | 127 Kg

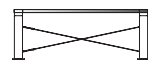

400 x 80 x 13 cm | 293 Kg
400 x 90 x 13 cm | 309 Kg

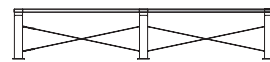

acabado | finish:

SMOOTH

color | colour:

White, metal, fusion, black

colocación | fixing:

Anclaje mecánico visto | Anchored with screws

complementos | complements:

• Pasamanos: en madera tropical o acero inox AISI 304 |
Handrail: tropical wood or stainless steel AISI 304

combinaciones combinations



Pasamanos en madera tropical/
Tropical wood handrail
h= 80/90cm
L= 130cm

Pasamanos en acero inox
AISI 304/ Stainless steel
AISI 304 handrail
h= 80/90cm
L= 200cm Ø5

opciones options

SEPARADORES METÁLICOS DECORATIVE METAL SPACER	
RUEDAS WHEELS	
LED	
REFLECTANTE REFLECTING	
HIDRO HYDRO	
TAPA TOP	
ARO SUJETA BOLSA TASH BAG FIXING RING	
CENICERO ASHTRAY	
APOYABRAZOS ARMREST	
RESPALDO BACKREST	
MODULABLE MODULABLE	●
WOODY/SYNTREWOOD	

breinco Colors

SMOOTH pulido e hidrofugado | polished and waterproofed



white



metal



fusion



black

geometría geometry

ESCALA 0 CM 25 CM

130 x 80/90 x 13 cm - Pasamanos madera | Wood handrail

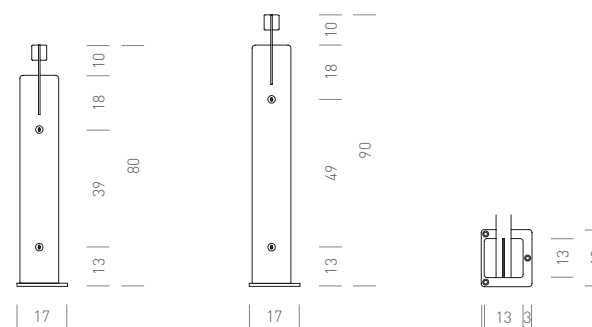

Frontal | Front view

Planta | Plan view

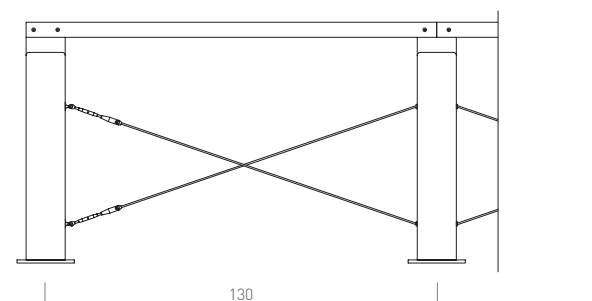

Lateral | Side view

TENSOR CADA 9m | TENSIONER EVERY 9m

200 x 80/90 x 13 cm - Pasamanos acero inox | Stainless steel handrail

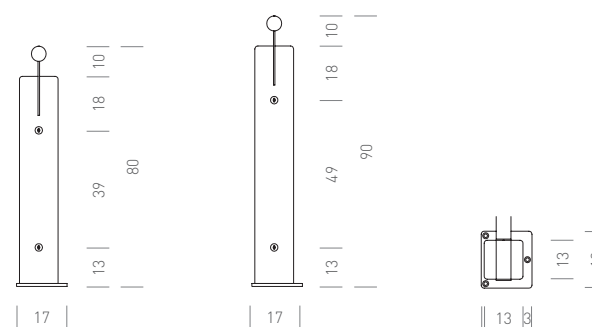

Frontal | Front view

Planta | Plan view

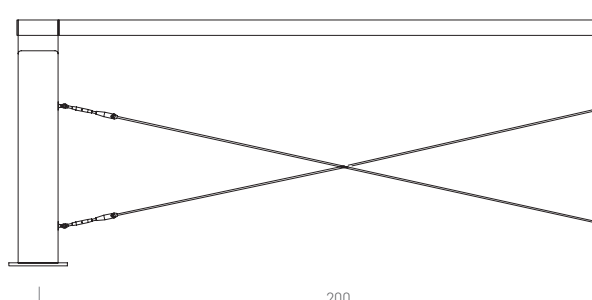

Lateral | Side view

TENSOR CADA 10m | TENSIONER EVERY 10m

instalación installation

Anclaje mecánico visto | Anchored with screws

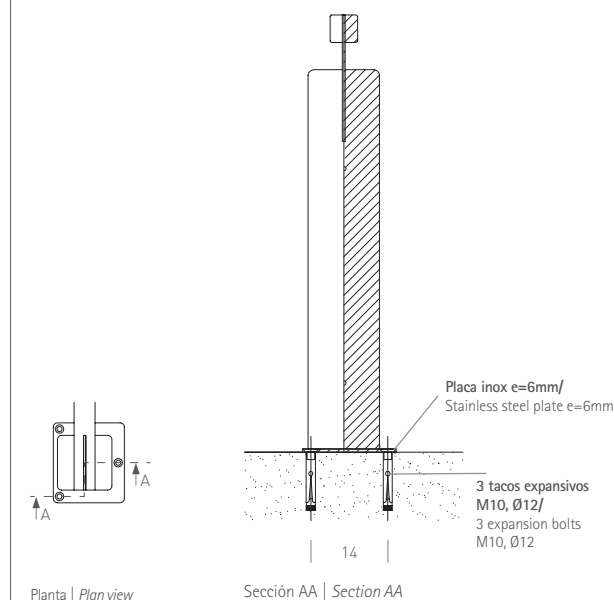

Planta | Plan view

Sección AA | Section AA

Se presentan los soportes al pavimento y se fija el pasamanos a los soportes. El soporte se fija mecánicamente al pavimento con una pletina de 170x190x6mm y tacos expansivos. Se colocan los cables de acero en forma de X.

La baranda se entrega desmontada.

Put the concrete supports on the floor. Fix the rail pipe to the supports. The support is anchored mechanically to the floor by means of a metal plate of 170x190x6 mm with expanding dowels. The steel strings are fixed in "X" form.

The handrail is delivered disassembled.

Características técnicas | Technical detail

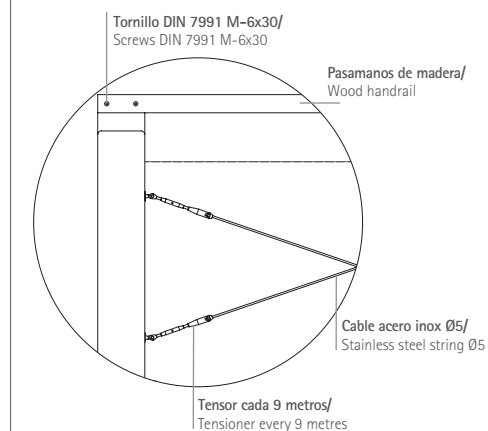

Tornillo DIN 7991 M-6x30/
Screws DIN 7991 M-6x30

Pasamanos de madera/
Wood handrail

Cable acero inox Ø5/
Stainless steel string Ø5

Tensor cada 9 metros/
Tensioner every 9 metres

angle font

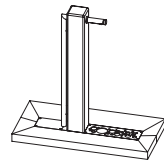

El monolito de hormigón smooth® característico de la familia Angle soporta el tubo y el grifo de la fuente Angle font. La reja de evacuación de agua ofrece dos posibilidades de diseño con geometrías diferentes.

The concrete pillar smooth®, characteristic of the Angle family, supports the tube and the tap of the Angle font fountain. The drainage grate offers two design possibilities with different geometries.

características characteristics



medidas | sizes:
76,5 x 96 x 13 cm
peso | weight:
Cuerpo | body: 43 Kg
Base | base: 10 Kg
Marco | gutter: 74 kg
acabado | finish:

SMOOTH

color | colour:
White, metal, fusion, black

colocación | fixing:

Anclaje mecánico visto | Anchored with screws

complementos | complements:

- Reja de evacuación de agua | Water drainage grate
 - Troquel lineal | Line die-cut
 - Troquel circular | Circle die-cut

combinaciones combinations

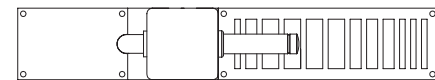

troquel lineal/
line die-cut

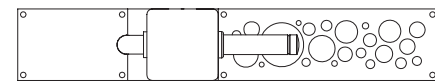

troquel circular/
circle die-cut

opciones options

SEPARADORES METÁLICOS DECORATIVE METAL SPACER	
RUEDAS WHEELS	
LED	
REFLECTANTE REFLECTING	
 HIDRO HYDRO	
TAPA TOP	
ARO SUJETA BOLSA TASH BAG FIXING RING	
CENICERO ASHTRAY	
APOYABRAZOS ARMREST	
RESPALDO BACKREST	
MODULABLE MODULABLE	
WOODY/SYNTREWOOD	

breinco Colors

SMOOTH pulido e hidrofugado | polished and waterproofed



white



metal



fusion



black

geometría geometry

ESCALA 0 CM 25 CM

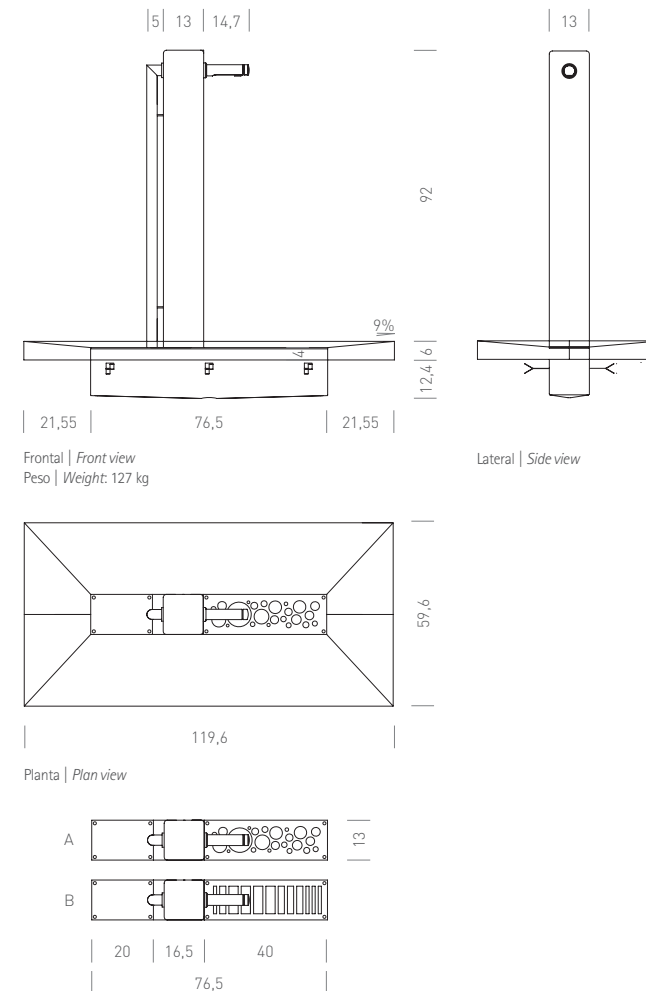

Reja de acero inoxidable AISI 304 | Stainless steel AISI 304 drain grate

instalación installation

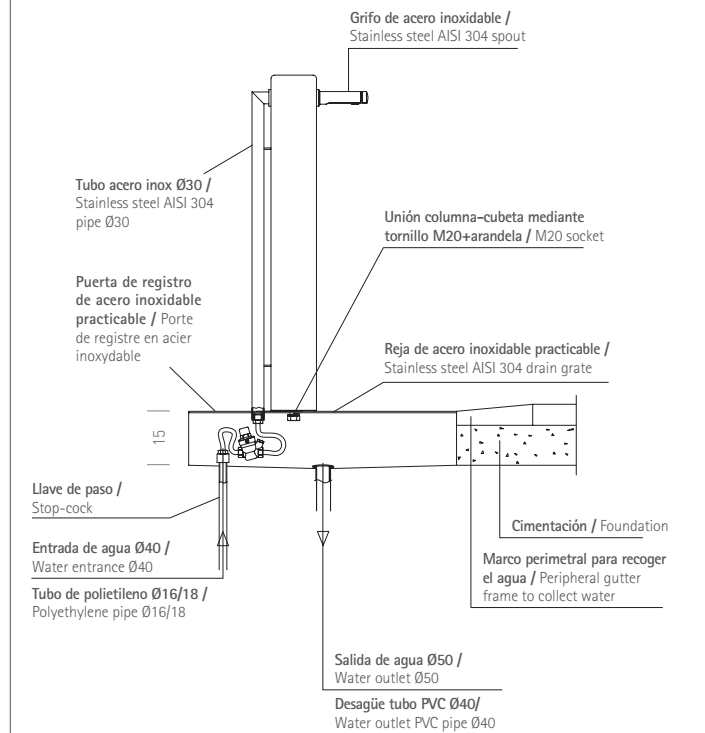

Se suministra en dos conjuntos premontados más el marco:
a) la columna con el tubo y el grifo
b) la cubeta con la tapa de registro y la reja montados
c) marco perimetral para recoger el agua

The gutter and two pre-assembled kits are supplied containing:
a) the pillar with the pipe and tap
b) the basin with fitted cover and grill
c) a peripheral gutter to collect water

Se requiere la previa instalación de los tubos tanto de desagüe como de alimentación.
Para la instalación se recomienda posicionar, nivelar y cimentar la base para una vez seca y rematada la colocación, montar la columna mediante el tornillo inferior M20. Para ello es necesario retirar momentáneamente la tapa de registro y la reja. Una vez fijada la columna instalar los elementos de regulación del agua.

The drain pipe and supply tubes both require previous installation. For the installation, it is recommend to position the base correctly, to level the ground and to lay the foundations. Once the location is dry and finished, the pillar can be fitted using the lower M20 screw. It will be necessary to momentarily remove the cover and grill in order to do this. Once the pillar is fitted, install the water regulation instruments.